

RAIS[®]

A R T O F  F I R E

Installation & Operation Manual RAIS Q-Tee II Gas Direct Vent Gas Stove



USA / Canada

⚠ WARNING**FIRE OR EXPLOSION HAZARD**

Failure to follow safety warnings exactly could result in serious injury, death, or property damage.

-Do not store or use gasoline or other flammable vapors and liquids in the vicinity of this or any other appliance.

WHAT TO DO IF YOU SMELL GAS

- Do not try to light any appliance.
- Do not touch any electrical switch; do not use any phone in your building.
- Leave the building immediately.
- Immediately call your gas supplier from a neighbor's phone. Follow the gas supplier's instructions.
- If you cannot reach your gas supplier, call the fire department.

- Installation and service must be performed by a qualified installer, service agency or the gas supplier.



This appliance may be installed in an aftermarket, permanently located manufactured home (USA only) or in a mobile home, where not prohibited by local codes.

This appliance is for use only with the type of gas indicated on the rating plate. This appliance is not convertible for use with other gases, unless a certified conversion kit is used.

Report # 103435815LHD-001

 <h2 style="margin: 0;">DANGER</h2>	 <h2 style="margin: 0;">DANGER</h2>
 <p style="text-align: center;">HOT GLASS WILL CAUSE BURNS.</p> <p style="text-align: center;">DO NOT TOUCH GLASS UNTIL COOLED.</p> <p style="text-align: center;">NEVER ALLOW CHILDREN TO TOUCH GLASS.</p> <p>A barrier designed to reduce the risk of burns from the hot viewing glass is provided with this appliance and shall be installed for the protection of children and other at-risk individuals.</p>	 <p style="text-align: center;">VITRE CHAUDE - RISQUE DE BRÛLURES.</p> <p style="text-align: center;">NE TOUCHEZ PAS UNE VITRE NON REFRIGIDIE.</p> <p style="text-align: center;">NE LAISSEZ JAMAIS UN ENFANT TOUCHER LA VITRE.</p> <p>L'écran pare-étincelles fourni avec ce foyer réduit le risque de brûlure en cas de contact accidentel avec la vitre chaude et doit être installé pour la protection des enfants et des personnes à risques.</p>

AVERTISSEMENT

Assurez-vous de bien suivre les instructions données dans cette notice pour réduire au minimum le risque d'incendie ou d'explosion ou pour éviter tout dommage matériel, toute blessure ou la mort.

Ne pas entreposer ni utiliser d'essence ni d'autres vapeurs ou liquides inflammables dans le voisinage de cet appareil ou de tout autre appareil.

-QUE FAIRE SI VOUS SENTEZ UNE ODEUR DE GAZ:

- **Ne pas tenter d'allumer d'appareil.**
- **Ne touchez à aucun interrupteur. Ne pas vous servir des téléphones se trouvant dans le bâtiment où vous trouvez.**
- **Appelez immédiatement votre fournisseur de gaz depuis un voisin. Suivez les instructions du fournisseur.**
- **Si vous ne pouvez rejoindre le fournisseur de gaz, appelez le service des incendies.**

- L'installation et l'entretien doivent être assurés par un installateur ou un service d'entretien qualifié ou par le fournisseur de gaz.

Cet appareil peut être installé dans une maison préfabriquée (mobile) déjà installée à demeure si les règlements locaux le permettent.

Cet appareil doit être uniquement avec le type de gaz indiqué sur la plaque signalétique. Cet appareil ne peut être converti à d'autres gaz, sauf si une trousse de conversion est utilisée.

Ne pas utiliser cet appareil s'il a été plongé, même partiellement, dans l'eau. Appeler un technicien qualifié pour inspecter l'appareil et remplacer toute partie du système de commande et toute commande qui a été plongée dans l'eau.

Attention. Au moment de l'entretien des commandes, étiquetez tous les fils avant de les débrancher. Des erreurs de câblage peuvent entraîner un fonctionnement inadéquat et dangereux.

S'assurer que l'appareil fonctionne adéquatement une fois l'entretien terminé.

AVERTISSEMENT. Ne pas utiliser l'appareil si le panneau frontal en verre n'est pas en place, est craqué ou brisé. Confiez le remplacement du panneau à un technicien agréé.

INSTALLATEUR: Laissez cette notice avec l'appareil.

COMSOMMATEUR: Conservez cette notice pour consultation ultérieure.

INSTALLER: Leave this manual with the appliance.

CONSUMER: Retain this manual for future reference.

This manual covers the following models:

12-0103 Q-Tee II Glass Gas
12-0123 Q-Tee II Classic Gas
12-0203 Q-Tee II Glass Gas - Low socket
12-0223 Q-Tee II Classic Gas - Low socket
12-0303 Q-Tee II Glass Gas - High socket
12-0323 Q-Tee II Classic Gas - High socket
12-0403 Q-Tee II Glass Gas - Low Legs
12-0423 Q-Tee II Classic Gas - Low Legs
12-0503 Q-Tee II Glass Gas - High Legs
12-0523 Q-Tee II Classic Gas - High Legs

12-0603 Q-Tee II C Glass Gas
12-0623 Q-Tee II C Classic Gas
12-0703 Q-Tee II C Glass Gas - Low socket
12-0723 Q-Tee II C Classic Gas - Low socket
12-0803 Q-Tee II C Glass Gas - High socket
12-0823 Q-Tee II C Classic Gas - High socket
12-0903 Q-Tee II C Glass Gas - Low Legs
12-0923 Q-Tee II C Classic Gas - Low Legs
12-1003 Q-Tee II C Glass Gas - High Legs
12-1023 Q-Tee II C Classic Gas - High Legs

TABLE OF CONTENTS

12-6510-US-CAN

Revision : 0

Date : 27-06-2018

IMPORTANT SAFETY INFORMATION	6
GENERAL COMMENTS	9
INTRODUCTION	10
GUARANTEE	11
SPECIFICATIONS.....	12
INSTALLATION.....	13
MASSACHUSETTS REQUIREMENTS	15
VENTING.....	16
GAS CONNECTION	27
CHANGES TO CHIMNEY CONNECTION.....	28
CONVERSION TO BOTTLED GAS (LPG)	31
ARRANGEMENT OF EMBERS AND CERAMIC LOGS	39
START-UP - INSERTION OF BATTERIES	43
SETTING UP OF THE ELECTRONIC CODE	45
COMMISSIONING	46
INITIAL IGNITION.....	48
USER INSTRUCTIONS.....	49
USING STOVE WITHOUT REMOTE CONTROL.....	55
SERVICE.....	57
MAINTENANCE INSTRUCTIONS.....	58
ACCESSORIES	62
INSTALLATION OF MYFIRE WI-FI BOX	63
SPARE PARTS LIST	65

FILL OUT THE INSTALLATION RECORD FORM,
IT CAN BE FOUND IN THE BACK OF THE MANUAL

WE STRONGLY SUGGEST THAT YOU READ THIS MANUAL THOROUGHLY BEFORE BEGINNING THE INSTALLATION OF THE RAIS GAS STOVE. ALTHOUGH THE BASIC REQUIREMENTS FOR THE INSTALLATION OF ALL DIRECT VENT GAS HEATERS ARE SIMILAR, EACH SPECIFIC PRODUCT HAS ITS OWN UNIQUE SET-UP AND INSTALLATION REQUIREMENTS THAT MUST BE FOLLOWED EXACTLY. PLAN YOUR INSTALLATION IN ADVANCE BY CAREFULLY REVIEWING ALL THE INFORMATION CONTAINED IN THIS MANUAL.

IMPORTANT SAFETY INFORMATION

THE INSTALLATION MUST CONFORM WITH LOCAL CODES OR, IN THE ABSENCE OF LOCAL CODES, WITH THE NATIONAL FUEL GAS CODE, ANSI Z223.1 OR THE CANADIAN INSTALLATION CODE, CAN/CGA B149.

A MANUFACTURED HOME (USA ONLY) OR MOBILE HOME OEM INSTALLATION MUST CONFORM WITH THE MANUFACTURED HOME CONSTRUCTION AND SAFETY STANDARD, TITLE 24 CFR, PART 3280 OR WHEN SUCH A STANDARD IS NOT APPLICABLE, THE STANDARD FOR MANUFACTURED HOME INSTALLATIONS, ANSI/BCSBCS A225.1, OR STANDARD FOR GAS EQUIPPED RECREATIONAL VEHICLES AND MOBILE HOUSING, CSA Z240.4.

THE APPLIANCE AND ITS APPLIANCE MAIN GAS VALVE MUST BE DISCONNECTED FROM THE GAS SUPPLY PIPING SYSTEM DURING ANY PRESSURE TESTING OF THAT SYSTEM AT TEST PRESSURES IN EXCESS OF 1/2 PSI (3.5 KPA).

THE APPLIANCE MUST BE ISOLATED FROM THE GAS SUPPLY PIPING SYSTEM BY CLOSING ITS EQUIPMENT SHUTOFF VALVE DURING ANY PRESSURE TESTING OF THE GAS SUPPLY PIPING SYSTEM AT TEST PRESSURES EQUAL TO OR LESS THAN 1/2 PSI (3.5 KPA).

THE INSTALLATION MUST PROVIDE FOR ADEQUATE VENTILATION AIR TO THE APPLIANCE.

THIS GAS APPLIANCE MUST NOT BE CONNECTED TO A CHIMNEY FLUE SERVING A SEPARATE SOLID-FUEL BURNING APPLIANCE.

THE APPLIANCE, WHEN INSTALLED, MUST BE ELECTRICALLY GROUNDED IN ACCORDANCE WITH LOCAL CODES, OR, IN THE ABSENCE OF LOCAL CODES, WITH THE NATIONAL ELECTRICAL CODE ANSI/NFPA 70, OR THE CANADIAN ELECTRICAL CODE, CSA C22. 1.

WHEN THE APPLIANCE IS INSTALLED DIRECTLY ON CARPETING OR NON-CERAMIC TILE OR OTHER COMBUSTIBLE MATERIAL OTHER THAN WOOD FLOORING, THE APPLIANCE SHALL BE INSTALLED ON A METAL OR WOOD PANEL EXTENDING THE FULL WIDTH AND DEPTH OF THE APPLIANCE. A COMMERCIALY AVAILABLE HEARTH PAD MEETS THIS REQUIREMENT.

THE APPLIANCE AREA MUST BE KEPT CLEAR AND FREE FROM COMBUSTIBLE MATERIALS, GASOLINE AND OTHER FLAMMABLE VAPORS AND LIQUIDS.

THE FLOW OF COMBUSTION AND VENTILATION AIR MUST NOT BE OBSTRUCTED.

DO NOT USE THIS APPLIANCE IF ANY PART HAS BEEN UNDER WATER. IMMEDIATELY CALL A QUALIFIED SERVICE TECHNICIAN TO INSPECT THE APPLIANCE AND TO REPLACE ANY PART OF THE CONTROL SYSTEM AND ANY GAS CONTROL WHICH HAS BEEN UNDER WATER.

DUE TO HIGH TEMPERATURES, THE APPLIANCE SHOULD BE LOCATED OUT OF TRAFFIC AND AWAY FROM FURNITURE AND DRAPERIES.

CHILDREN AND ADULTS SHOULD BE ALERTED TO THE HAZARDS OF HIGH SURFACE TEMPERATURES AND SHOULD STAY AWAY TO AVOID BURNS OR CLOTHING IGNITION.

YOUNG CHILDREN SHOULD BE CAREFULLY SUPERVISED WHEN THEY ARE IN THE SAME ROOM AS THE APPLIANCE. TODDLERS, YOUNG CHILDREN AND OTHERS MAY BE SUSCEPTIBLE TO ACCIDENTAL CONTACT BURNS. A PHYSICAL BARRIER IS RECOMMENDED IF THERE ARE AT-RISK INDIVIDUALS IN THE HOUSE. TO RESTRICT ACCESS TO A FIREPLACE OR STOVE, INSTALL AN ADJUSTABLE SAFETY GATE TO KEEP TODDLERS, YOUNG CHILDREN AND OTHER AT-RISK INDIVIDUALS OUT OF THE ROOM AND AWAY FROM HOT SURFACES.”

CLOTHING OR OTHER FLAMMABLE MATERIAL SHOULD NOT BE PLACED ON OR NEAR THE APPLIANCE.

ANY SCREEN OR GUARD REMOVED FOR SERVICING AN APPLIANCE MUST BE REPLACED PRIOR TO OPERATING THE APPLIANCE.

INSTALLATION AND REPAIR SHOULD BE DONE BY A QUALIFIED SERVICE PERSON.

THE APPLIANCE SHOULD BE INSPECTED BEFORE USE AND AT LEAST ANNUALLY BY A PROFESSIONAL SERVICE PERSON.

MORE FREQUENT CLEANING MAY BE REQUIRED DUE TO EXCESSIVE LINT FROM CARPETING, BEDDING MATERIAL, ETC. IT IS IMPERATIVE THAT THE CONTROL COMPARTMENTS, BURNERS AND CIRCULATING AIR PASSAGEWAYS OF THE APPLIANCE BE KEPT CLEAN.

A BARRIER DESIGNED TO REDUCE THE RISK OF BURNS FROM THE HOT VIEWING GLASS IS PROVIDED WITH THIS APPLIANCE AND SHALL BE INSTALLED FOR THE PROTECTION OF CHILDREN AND OTHER AT-RISK INDIVIDUALS.

12-0000-19010190 - Q-TEE II GAS BLACK

IF THE BARRIER BECOMES DAMAGED, THE BARRIER SHALL BE REPLACED WITH THE MANUFACTURER'S BARRIER FOR THIS APPLIANCE.

12-0000-19010290 - Q-TEE II C GAS BLACK 12-0000-19010295 - Q-TEE II C GAS PLATIN

IF THE BARRIER BECOMES DAMAGED, THE BARRIER SHALL BE REPLACED WITH THE MANUFACTURER'S BARRIER FOR THIS APPLIANCE.

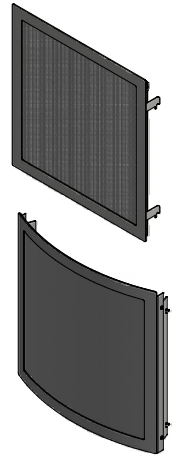

WARNING: Do not operate the appliance with the glass door assembly removed, or if the glass is cracked or broken. Replacement of the glass should be done by a qualified service person.

WARNING: Use only door assembly that includes the glass panel, frame and gas ket. Do not use substitute materials. Do not strike or slam the glass front. Do not use abrasive cleaners. Do not clean when hot.

NE PAS SE SERVER DE CET APPAREIL S'IL A ÉTÉ PLUNGE DANS L'EAU, MÊME PARTIELLEMENT. FAIRE INSPECTER L'APPAREIL PAR UN TECHNICIEN QUALIFIÉ ET REMPLACER TOUTE PARTIE DU SYSTÈME DE CONTRÔLE ET TOUTE COMMANDE QUI ONT ÉTÉ PLONGÉES DANS L'EAU.

CET APPAREIL PEUT ÊTRE INSTALLÉ DANS UNE MAISON PRÉFABRIQUÉE (MOBILE) DÉJÀ INSTALLÉE À DEMEURE SI LES RÈGLEMENTS LOCAUX LE PERMETTENT.

CE APPAREIL DOIT ÊTRE UTILISÉ UNIQUEMENT AVEC LE TYPE DE GAZ INDIQUÉ SUR LA PLAQUE SIGNALÉTIQUE. CET APPAREIL NE PEUT ÊTRE CONVERTI À D'AUTRES GAZ, SAUF SI UNE TROUSSE DE CONVERSION EST UTILISÉ.

EN RAISON DES TEMPÉRATURES ÉLEVÉES, L'APPAREIL DEVRAIT ÊTRE INSTALLÉ DANS UN ENDROIT OÙ IL Y A PEU DE CIRCULATION ET LOIN DU MOBILIER ET DES TENTURES.

LES ENFANTS ET LES ADULTES DEVRAIENT ÊTRE INFORMÉS DES DANGERS QUE POSENT LES TEMPÉRATURES DE SURFACE ÉLEVÉES ET SE TENIR À DISTANCE AFIN D'ÉVITER DES BRÛLURES OU QUE LEURS VÊTEMENTS NE S'ENFLAMMENT.

LES JEUNES ENFANTS DEVRAIENT ÊTRE SURVEILLÉS ÉTROITEMENT LORSQU'ILS SE TROUVENT DANS LA MÊME PIÈCE QUE L'APPAREIL. LES TOUT PETITS, LES JEUNES ENFANTS OU LES ADULTES PEUVENT SUBIR DES BRÛLURES S'ILS VIENNENT EN CONTACT AVEC LA SURFACE CHAUDE. IL EST RECOMMANDÉ D'INSTALLER UNE BARRIÈRE DE SÉCURITÉ; CETTE MESURE EMPÊCHERA LES TOUT PETITS, LES JEUNES ENFANTS ET TOUTE AUTRE PERSONNE À RISQUÉ D'AVOIR ACCÈS À LA PIÈCE ET AUX SURFACES CHAUDES.

UN ÉCRAN DESTINÉ À RÉDUIRE LE RISQUÉ DE BRÛLURE ATTRIBUTABLE À LA VITRE CHAUDE EST FOURNI AVEC CET APPAREIL ET DEVRAIT ÊTRE INSTALLÉ POUR LA PROTECTION DES ENFANTS ET DES PERSONNES À RISQUÉ.

SI L'ÉCRAN EST ENDOMMAGÉ, IL DOIT ÊTRE REMPLACÉ PAR CELUI FOURNI PAR LE FABRICANT DE CET APPAREIL.

ON NE DEVRAIT PAS PLACER DE VÊTEMENTS NI D'AUTRES MATIÈRES INFLAMMABLES SUR L'APPAREIL NI À PROXIMITÉ.

TOUT ÉCRAN OU PROTECTEUR RETIRÉ POUR PERMETTRE L'ENTETIEN DE L'APPAREIL DOIT ÊTRE REMIS EN PLACE AVANT DE METTRE L'APPAREIL EN MARCHÉ.

L'INSTALLATION ET LA RÉPARATION DEVRAIT ÊTRE CONFIEES À UN TECHNICIEN QUALIFIÉ. L'APPAREIL DEVRAIT FAIRE L'OBJET D'UNE INSPECTION PAR UN TECHNICIEN PROFESSIONNEL AVANT D'ÊTRE UTILISÉ ET AU MOINS UNE FOIS L'AN PAR LA SUITE. DES NETTOYAGES PLUS FRÉQUENTS PEUVENT ÊTRE NECESSAIRES SI LES TAPIS, LA LITERIE, ET CETERA PRODUISENT UNE QUANTITÉ IMPORTANTE DE POUSSIÈRE. IL EST ESSENTIEL QUE LES COMPARTIMENTS ABRITANT LES COMMANDES, LES BRÛLURES ET LES CONDUITS DE CIRCULATION D'AIR DE L'APPAREIL SOIENT TENUS PROPRES.

SEULES LES TROUSSES DE GARNITURE FOURNIES PAR LE FABRICANT DOIVENT ÊTRE UTILISÉES POUR L'INSTALLATION DE CET APPAREIL.

AVERTISSEMENT: RISQUE DE DOMMAGES OU DE BLESSURES SI LES PIÈCES NE SONT PAS INSTALLÉES CONFORMÉMENT À CES SCHEMAS ET OU SI DES PIÈCES AUTRES QUE CELLES SPÉCIFIQUEMENT APPROUVÉES AVEC CET APPAREIL SONT UTILISÉES.

LES DÉGAGEMENTS SONT CONFORMES AUX CODES D'INSTALLATION LOCAUX ET AUX EXIGENCES DU FOURNISSEUR DE GAZ.

General Comments

This RAIS product is an extremely effective convection gas stove with a sealed combustion chamber for chimneys with a balanced draught. It is fitted with a burner with the latest burner technology. It has a variable heat output because it uses a special control system that makes it possible to use three burners for high output or one burner for a lower output. One of the burners, called the "Main burner" is located in the centre of the stove, the second and third burners, called the "Secondary burners" are located behind the Main burner. The secondary burners can be switched on and off while the stove is on.

Where there is a natural gas connection, the local gas supply conditions should be investigated to ensure that the gas composition and pressure suit the stove's settings.

If the stove is connected to bottled gas, only gas bottles fitted with a gas regulator (Low pressure regulator) providing the correct gas pressure may be connected. For this reason, gas bottles without a regulator must not be connected.

This stove must only be installed, set up and serviced by an authorised and qualified plumbing and heating engineer/Gas installer. The installation must comply with local and national Building Regulations and Gas Regulations and the user manual must be adhered to. The user manual should be left with the customer, who should keep this for later use. The manual is necessary when the stove is to be serviced.

Ensure that the chimney terminal is not blocked in any way and is free of vegetation in the form of trees, bushes etc. and that objects are not resting against the chimney's terminal or the protection around the terminal.

The door glass should always be cleaned before the stove is turned on and fingerprints wiped as these can be burned into the glass.

The stove must not be used if the door glass is split, cracked, removed or if the door is open. Do not use the stove if the door gasket is broken or worn.

This stove is designed for use in many different installation situations, which can be seen in this manual. Only chimneys approved by RAIS may be used with this product. (see chimney section)

This stove is intended for chimneys with balanced draughts (Air intake and draught in same chimney) so there is no need for any extra air supply for combustion. Suitable ventilation is recommended in the room in order to achieve a pleasant living environment.

This product is a heating appliance so the surfaces become very hot and should not be touched during use. It is therefore recommended that you use an approved stove screen to protect children, older people and persons with reduced mobility in the same area as the stove.

Keep curtains, washing, furniture etc. at a minimum distance of 300 mm from this stove. The stove must not be used for burning waste.

If the stove is extinguished or goes out, do not attempt to turn it back on until a minimum of 3 minutes have passed.

Introduction

congratulations with your new RAIS Product.

A RAIS stove is more than just a source of heat, it also expresses how you put the emphasis on good design and high quality in your home.

In order get the most pleasure and benefit from your new stove, it is important that you read the manual thoroughly before it is installed and put to use.

For the purpose of the guarantee and all contact regarding the stove in general, it is important that you can state the stove's production number. We therefore recommend that you write down the number in the form below. Also write down where the stove was bought and who installed the stove.

The production number can be found at the bottom of the stove.

Production number: <input type="text"/>
Produced by: RAIS A/S 9900 Frederikshavn, DK

Guarantee

RAIS stoves are checked several times with regard to safety, as well as the quality of materials and manufacturing. We offer a guarantee on all models and the guarantee commences on the date of installation.

The guarantee covers:

- documented functional faults due to incorrect manufacture
- documented material faults

The guarantee does not cover:

- door and glass gaskets
- ceramic glass
- the appearance of the surface structure or texture of the natural stone
- the appearance of the stainless steel and colour changes and patina
- expansion blemishes
- batteries

The guarantee is invalidated in the event of:

- damage due to overfiring
- damage due to external influences and the use of unsuitable fuels
- failure to comply with statutory or recommended installation instructions and in the event the user's own modifications of the stove.
- lack of servicing and care

In the event of damage, please contact your dealer. In the event of claims under the guarantee, we will decide how the damage is to be repaired. In the event of repairs, we will ensure they are performed professionally.

In the event of guarantee claims concerning repaired parts or parts delivered later, please refer to national/EU law/provisions in relation to renewed guarantee periods.

The guarantee provisions applying at any time may be requested from RAIS

SPECIFICATIONS

INPUT

	Natural Gas	Propane (LP)
Input Rating-Btu/hr	31,000	25,600
Min. Input-Btu/hr	8,000	8,000
Orifice-Marking (Front)	120	80
Orifice-Marking (Rear)	260 (x2)	100 (x2)

GAS SUPPLY

Manifold Pressure	4.0" w.c. / 1.0kPa	10.8" w.c. / 2.7kPa
Min. Supply Pressure	4.0" w.c. / 1.0kPa	11.0" w.c. / 2.8kPa
Max. Supply Pressure	10.0" w.c. / 2.5kPa	13.0" w.c. / 3.3kPa

EFFICIENCY

Steady State Efficiency (At Min. Input Rate and Using Minimum Allowable Vent Length)-%

Top Vent / Rear Vent	78	78.2
Annual Fuel Utilization Efficiency [AFUE](Using Minimum Allowable Vent Length) -%		
Top Vent / Rear Vent	77	77
Canadian p.4 Efficiency (Using Minimum Allowable Vent Length)- %		
Top Vent / Rear Vent	70 / 72	69 / 70
Maximum Observed		
-Steady State Efficiency -%	73.6	70.1

NOTE: The maximum achievable steady state efficiency can vary depending the installation and on how the stove is operated.

It is recommended that the pilot flame be turned off if the appliance will not be in use for an extended period of time. This appliance is equipped for use with the fuel type indicated on the rating plate. Fuel conversion kits that include the necessary parts and instructions are included with the stove or are available from your installer, dealer or RAIS.

This appliance has been certified by Intertek, Inc. to ANSI Z21.50 • CSA 2.22 Vented Gas Fireplace Heaters and CGA 2.17-M91 (R2009), Gas-Fired Appliances for Use At High Altitudes.

The appliance is approved for installation at elevations up to 4500 feet (1370 meters) in U.S. and Canada without change. If your installation is at an elevation greater than these, consult with the local authority having jurisdiction for gas product installations to determine their specific requirements for high altitude installations.

Intertek Testing & Certification Ltd,
Registered office: Academy Place, 1 to 9 Brook Street, Brentwood, Essex
CM14 5NQ, United Kingdom. Registered No: 3272281
(England), VAT No: GB 672-7639-96-011
T: +44 1277 223 400
F: +44 1277 223 127

INSTALLATION

Several issues must be addressed when selecting a suitable location for your appliance. The minimum clearances to combustible construction are listed below. In addition, access to the gas supply must be considered. The location of the stove will also affect the venting requirements and you must be certain the location will allow compliance with the venting requirements. You must also insure that your installation provides adequate accessibility clearance for servicing and proper operation.

When the appliance is installed directly on carpeting or non-ceramic tile or other combustible material other than wood flooring, the appliance shall be installed on a metal or wood panel extending the full width and depth of the appliance. A commercially available hearth pad meets this requirement.

Installation and repair should be done by a qualified service person. The appliance should be inspected before use and at least annually by a professional service person. More frequent cleaning may be required due to excessive lint from carpeting, bedding material, etc. It is imperative that the control compartment, burners and circulating air passageways of the appliance be kept clean.

Gas installation

Once it has been decided where the stove will be positioned, a gas installation should be established in the vicinity of the stove so that the gas supply and stove can be connected.

Ventilation

This stove has a sealed combustion chamber and is intended for a balanced draught. There is therefore no need for an extra air supply.

It is recommended that sufficient fresh air is supplied to the room to maintain a comfortable environment.

This stove may be installed in a completely airtight building or a building with mechanical ventilation.

UNPACKING AND PLACING.

By now, you will have removed the shipping carton from the base pallet. The appliance is shipped in a specially designed shipping carton. Cut the strapping that secures the stove to the pallet and remove the wooden cribbing from the top of the stove. Remove the plastic bag that covers the stove. Remove the barrier, be careful not to scratch the paint of the stove when removing the barrier. Open the door with the 10mm spanner fixed to the pallet, by turning the two hooks holding the door. Remove the package of logs and accessories that is packed inside the stove and set it aside. Lift the stove up and off the pallet. Remove transit packing material. Remove any packing material from inside the firebox.

The appliance is equipped with leveling bolts to make it easier to install the stove on an irregular surface. They can be adjusted later. Move the appliance to the location where it will be installed. Using as little adjustment as possible for each leveling bolt, adjust them as needed to get the stove as level as possible both side to side and front to back.

MINIMUM CLEARANCES TO COMBUSTIBLE CONSTRUCTION

Stove to Left Side Wall	10" (250mm)	Stove to Corner Wall	2" (50mm)
Stove to Right Side Wall	10" (250mm)	Stove to Ceiling	35" (890mm)
Stove to Rear Wall	2" (50mm)	Stove to 12" Deep Mantel	12" (305mm)
Max. Alcove Depth	24" (610mm)	Stove to 1½" Trim	2" (50mm)

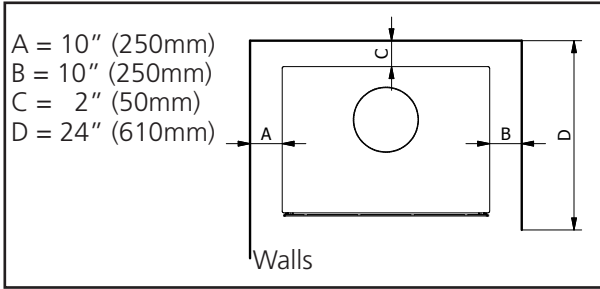

F = 35" (890mm)
 G = 12" (305mm)
 H = 12" (305mm) Max.
 I = 2" (50mm)

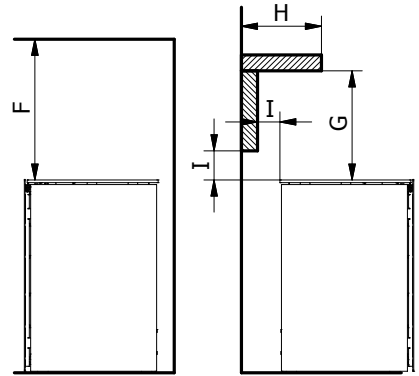
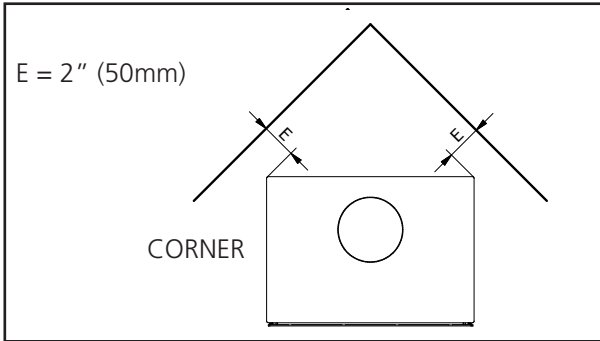

PLEASE NOTE!

The floor construction must be able to bear the weight of the stove and chimney, if applicable. If the existing design does not satisfy this prerequisite, suitable measures must be taken (e.g., a load distribution slab). Consult a construction expert.

The stove must be positioned at a safe distance from flammable material. It must be ensured that flammable objects (e.g., furniture) are not positioned closer than the distances stated in the following sections with regard to installation (risk of fire).

When you choose where you wish to position your stove, you should consider the heat distribution to the other rooms. Then you will get the maximum possible pleasure from your stove.

Inspect the stove for defects upon receipt.

MASSACHUSETTS REQUIREMENTS

The gas stove is shipped with a 3/8" NPT female connection. The gas supply piping should have a separate gas shutoff valve and a 1/8" NPT plugged tapping upstream of the valve. The stove and its main control valve must be disconnected from the gas supply piping system during any pressure testing of that system at test pressures in excess of 1/2 psi (3.5 kPa). The stove must be isolated from the gas supply piping system by closing the main control valve during any pressure testing of the gas supply system at test pressures equal to or less than 1/2 psi (3.5 kPa). After the gas supply has been connected, use a commercial gas leak detector or apply a soapy water solution to all the fittings to check for gas leaks. Never use a flame to test for leaks.

REQUIREMENTS FOR THE COMMONWEALTH OF MASSACHUSETTS

This product must be installed by a licensed plumber or gas fitter when installed within the Commonwealth of Massachusetts. If this appliance is installed in a dwelling, building or structure used in whole or in part for residential purposes and the installation includes a horizontal vent termination that is less than seven (7) feet above the finished grade in the area of the venting, including but not limited to decks and porches, a hard-wired carbon monoxide detector with an alarm and battery back-up must be installed on the floor level of the dwelling, building or structure where the appliance is to be installed.

Additionally, a hard-wired or battery operated carbon monoxide detector with an alarm must be installed on each additional level of the dwelling, building or structure served by the appliance. It shall be the responsibility of the property owner to secure the services of qualified licensed professionals for the installation of hard-wired carbon monoxide detectors.

In the event that the horizontally vented appliance is installed in a crawl space or attic, the hard-wired carbon monoxide detector with alarm and battery back-up may be installed on the next adjacent floor level.

In the event that this requirement cannot be met at the time of completion of the installation of the appliance, the owner shall have a period of thirty (30) days to comply with the requirement. However, during said thirty

(30) day period, a battery operated carbon monoxide detector with alarm must be installed.

Each carbon monoxide detector as required in accordance with the above provisions must comply with NFPA 720 and be ANSI/UL 2034 and IAS certified.

In addition when the stove is horizontally vented and the vent termination is less than seven (7) feet above finished grade a metal or plastic identification plate must be permanently mounted to the exterior of the building at a minimum height of eight (8) feet above grade directly in line with the exhaust vent terminal. The sign shall read, in print size no less than one-half (1/2) inch in size, "GAS VENT DIRECTLY BELOW. KEEP CLEAR OF ALL OBSTRUCTIONS".

A COPY OF THESE INSTRUCTIONS PLUS ALL VENTING INSTRUCTIONS WHICH INCLUDE PARTS LISTS, AND/OR ALL VENTING DESIGN INSTRUCTIONS MUST REMAIN WITH THE STOVE AT THE COMPLETION OF THE INSTALLATION.

ATTENTION INSTALLERS: Mark below which venting system was used in the installation. These instructions must remain with the Installation & Operation Manual.

Simpson DuraVent GS AmeriVent Direct Selkirk DT

BDM Pro-Form DVS ICC EXCEL Direct OLYMPIA CHIMNEY SUPPLY Ventis

VENTING

This Gas Stove has been tested and listed for installation with 4" X 6 5/8" Simpson DuraVent GS®, AmeriVent Direct® , Selkirk DT® , BDM Pro-Form DVS®, ICC EXCEL Direct® and OLYMPIA CHIMNEY SUPPLY Ventis® direct venting components. For specific installation requirements, follow the installation instructions included by the venting manufacturer with the venting system components you have chosen. The total horizontal vent length may not exceed 50 feet (15m) The vent lengths are measured from the stove, not the floor. The minimum vertical vent rise when using a vertical vent termination is 2 feet (600mm). The minimum vertical rise required when using a horizontal vent termination is 2 feet (600mm). For venting system installation details, refer to the instructions provided with the venting system you have chosen. Each brand has specific installation requirements that must be followed to insure a safe and functional venting system.

Horizontal Wall Vent Termination

Flue sizing:

Ø4"x6 5/8" Connector on Appliance.

Ø4"x6 5/8" Maybe used Throughout, Alternatively,

Ø5"x8" Expander may be used, so that Ø5"x8" flue can be used thereafter.

Flue Terminal: Ø4"x6 5/8" Alternatively, Ø5"x8" Maximum pipe extension, for out side wall (H)

= 4 X Vertical Pipe Rise (V) -1. For Ø5"x8" flue.

= 2 X Vertical Pipe Rise (V) . For Ø4"x6 5/8" flue.

Maximum Permissible horizontal run (H) =50 feet (15m).

Vertical Rise		Horizontal Run Ø5"x8" Flue		Horizontal Run Ø 4"x6 5/8" Flue	
Feet	metres	Feet	metres	Feet	metres
2'	0.6	7'6"	2.3	4'	1.2
3'	0.9	11'6"	3.5	6'	1.8
4'	1.2	15'6"	4.7	8'	2.4
5'	1.5	19'6"	5.9	10'	3.0
6'	1.8	23'6"	7.2	12'	3.7
7'	2.1	27'6"	8.4	14'	4.3
8'	2.4	31'6"	9.6	16'	4.9
9'	2.7	35'6"	10.8	18'	5.5
10'	3.0	39'6"	12.0	20'	6.1
11'	3.4	43'6"	13.3	22'	6.7
12'	3.7	47'6"	14.5	24'	7.3
13'	4.0	50'	15	26'	7.9
14'	4.3	50'	15	28'	8.5
15'	4.6	50'	15	30'	9.1
16'	4.9	50'	15	32'	9.8
17'	5.2	50'	15	34'	10.4
18'	5.5	50'	15	36'	11.0
19'	5.8	50'	15	38'	11.6
20'	6.1	50'	15	40'	12.2
21'	6.4	50'	15	42'	12.8
22'	6.7	50'	15	44'	13.4
23'	7.0	50'	15	46'	14.0
24'	7.3	50'	15	48'	14.6
25'	7.6	50'	15	50'	15

Minimum Vertical Flue Height: - 2 feet (600mm)

Flue Restrictors to be fitted, $\text{Ø} 4" \times 6 \frac{5}{8}"$:

Vertical Rise	< 3 feet (1m)	-	No Restrictor
Vertical Rise	3 – 8 feet (1-2m)	-	$\text{Ø}62\text{mm}$ Restrictor
Vertical Rise	> 8feet (2m)	-	$\text{Ø}76\text{mm}$ Restrictor

Vertical Roof Vent Termination

Flue sizing:

$\text{Ø}4" \times 6 \frac{5}{8}"$ Connector on Appliance.
 $\text{Ø}4" \times 6 \frac{5}{8}"$ Maybe used Throughout, Alternatively,
 $\text{Ø}5" \times 8"$ Expander may be used, so that $\text{Ø}5" \times 8"$ flue can be used
 thereafter.

Flue Terminal: $\text{Ø}4" \times 6 \frac{5}{8}"$ Alternatively, $\text{Ø}5" \times 8"$

Minimum Vertical Flue Height: - 2 feet (600mm)

Flue Restrictors to be fitted, $\text{Ø} 4" \times 6 \frac{5}{8}"$:

Vertical Rise	< 3 feet (1m)	-	No Restrictor
Vertical Rise	3 – 8 feet (1-2m)	-	$\text{Ø}62\text{mm}$ Restrictor
Vertical Rise	> 8feet (2m)	-	$\text{Ø}76\text{mm}$ Restrictor

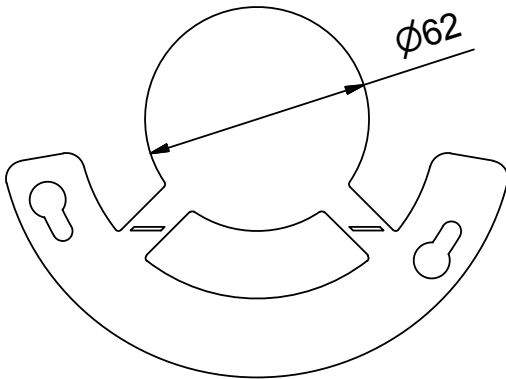

3711307 -
Small Restrictor D62

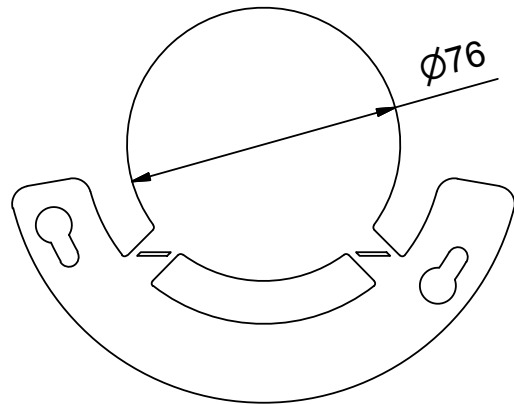

3711308 -
Large Restrictor D76

Vertical Roof Termination

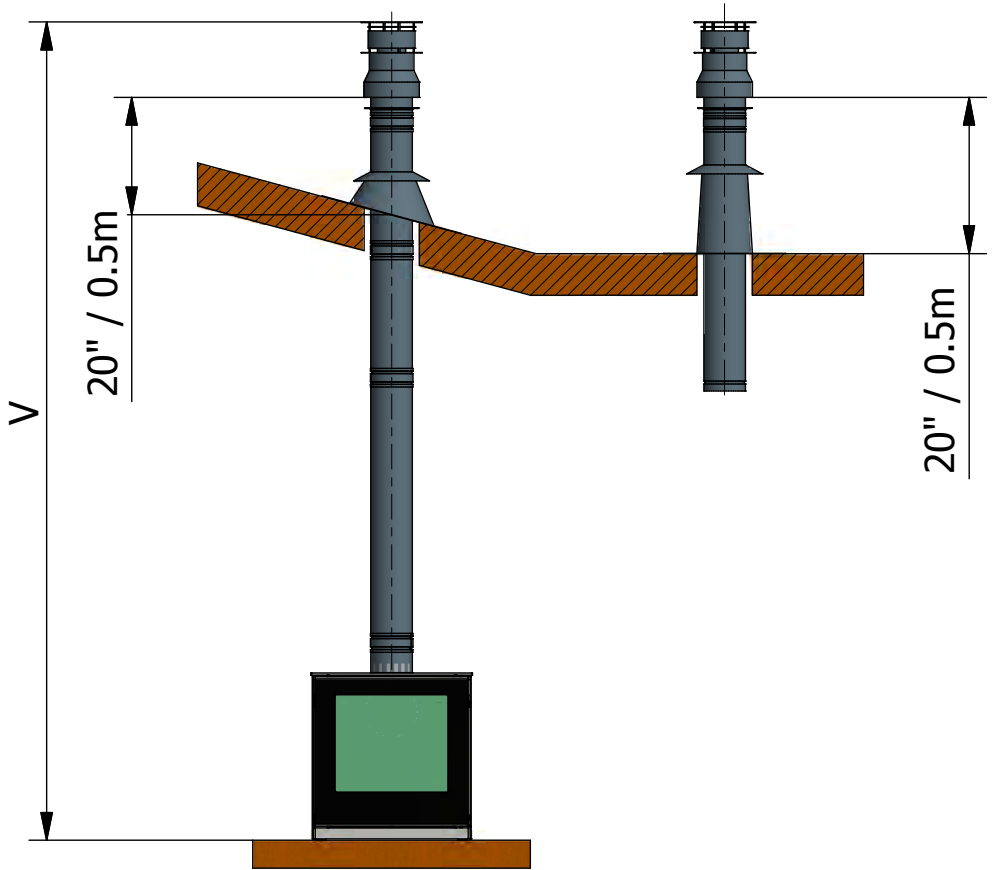

Distance "V" 20" - 50' (500mm - 12m) (min - max)

Vertical Roof Termination on angle

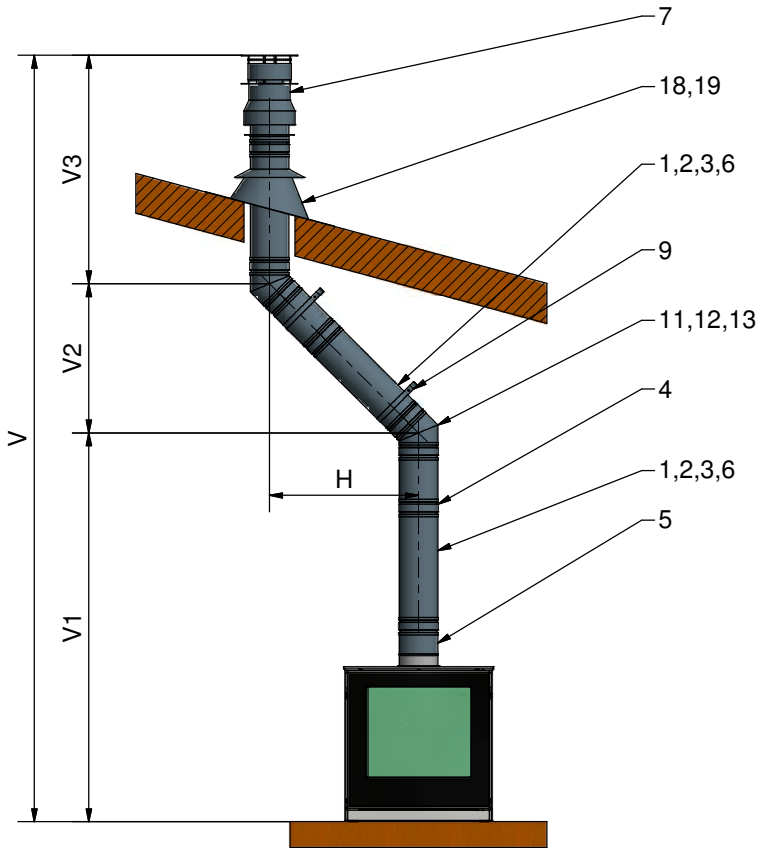

Distance "H" = 0 - 15' (3m) (min - max)
 Distance "V1" = 20" (500mm) - 30' (10m) (min - max)
 Distance "V2" = 8" (200mm) - 30' (10m) (min - max)
 Distance "V3" = 20" (500mm) - 30' (10m) (min - max)
 Distance "V" (= V1+V2+V3) = 4' (1.2m) - 50' (15m) (min - max)

Distance "V" = 2 X "H" (min)

Vertical Roof Termination with bends

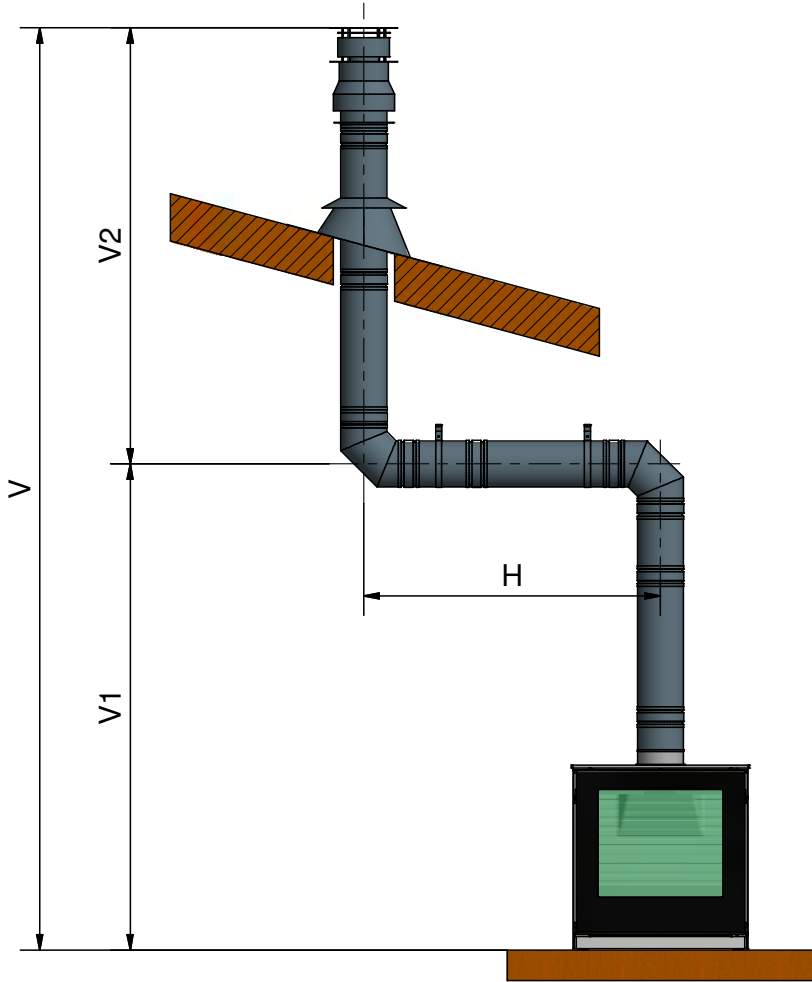

Distance "H" = 0 - 15' (3m) (min - max)
 Distance "V1" = 20" (500mm) - 30' (10m) (min - max)
 Distance "V2" = 8" (200mm) - 30' (10m) (min - max)
 Distance "V" (= V1+V2+V3) = 4' (1.2m) - 50' (15m) (min - max)

Distance "V" = 2 X "H" (min)

Vertical Roof Termination with Back outlet.

see table under Horizontal Wall Vent Termination

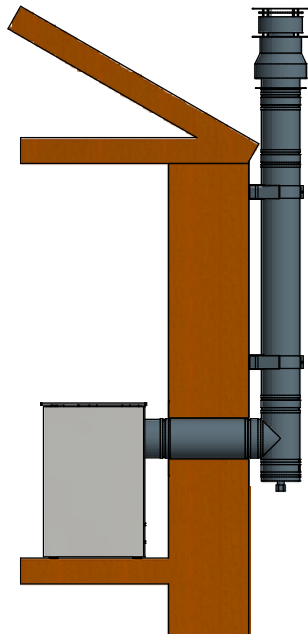

Wall Termination - Snorkel

see table under Horizontal Wall Vent Termination

Top Outlet

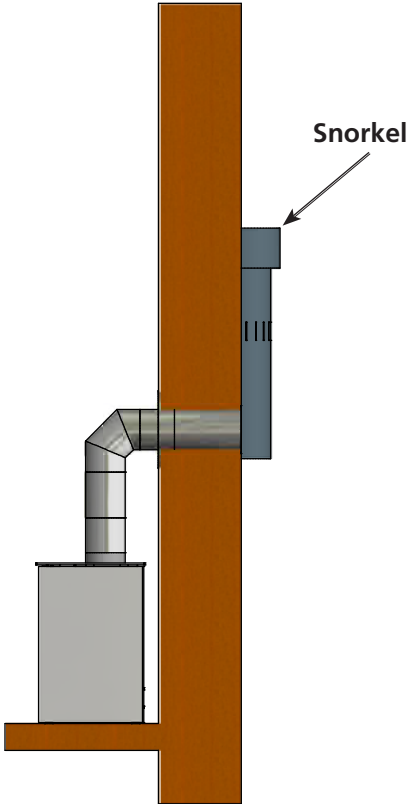

Back Outlet

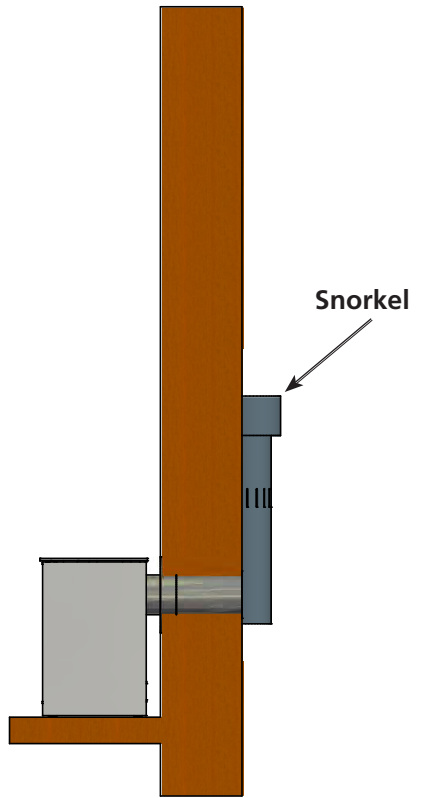

Wall Termination - Snorkel

see table under Horizontal Wall Vent Termination

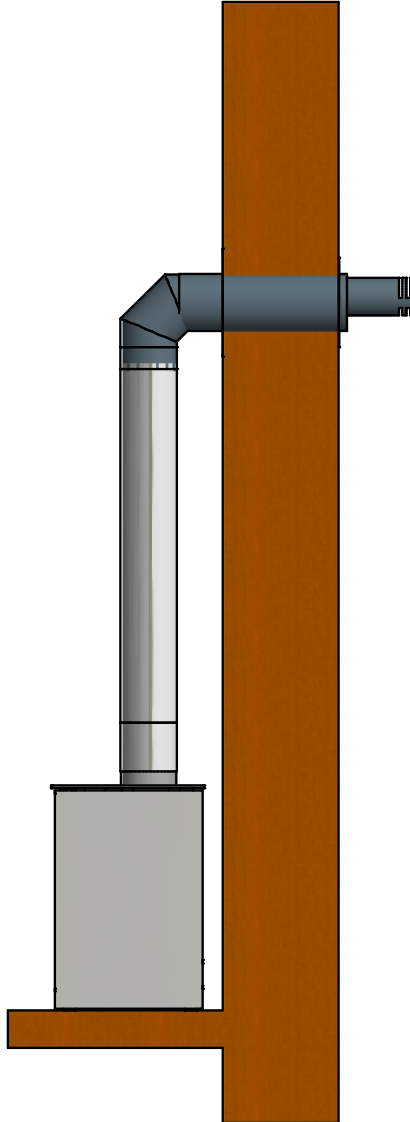

PLEASE NOTE: If your specific venting configuration is over 15 feet (4.5m), you must use one of the approved direct vent venting systems that utilizes a stainless steel inner liner. This requirement is part of the ANSI standards and is based on testing conducted to determine where the exhaust gas temperature drops to the point where condensation might occur in the vent pipe. The standards require the use of corrosion resistant liner materials if that specific total vent length is exceeded.

Required direct vent terminal clearances (twin pipe / concentric penetration)

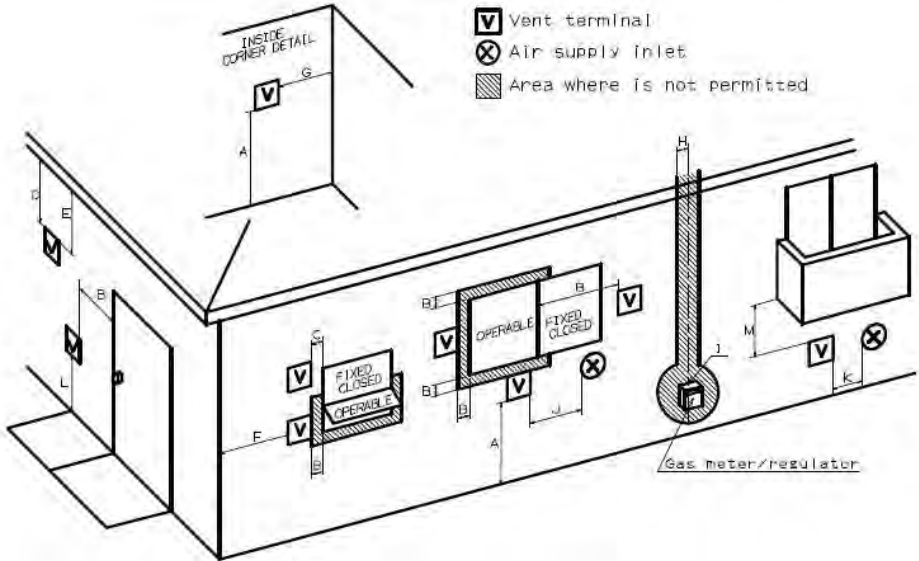

VENT TERMINAL CLEARANCES (Refer to illustration on page 15)

	Canadian installations ¹	U.S. installations ²
A = Clearance above grade, veranda, porch, deck or balcony	12 inches (30 cm)	12 inches (30 cm)
B = Clearance to window or door that may be opened	12 inches (30 cm)	9 inches (23 cm)
C = Clearance to a permanently closed window	See Footnotes 5& 6	See Footnotes 5
D = Vertical clearance to a ventilated soffit located above the terminal within a horizontal distance of 2 feet (61cm) from the centerline of the terminal	See Footnotes 5& 6	See Footnotes 5
E = Clearance to unventilated soffit	See Footnotes 5& 6	See Footnotes 5
F = Clearance to outside corner	See Footnotes 5& 6	See Footnotes 5
G = Clearance to inside corner	See Footnotes 5& 6	See Footnotes 5
H = Clearance to each side of centerline extended above meter/regulator assembly	3 feet (91 cm) within a height of 15 feet (4.5m) above the regulator / meter assembly	See Footnotes 5
I = Clearance to service regulator vent outlet	3 feet (91 cm)	See Footnotes 5
J = Clearance to non-mechanical air supply inlet to building or the combustion air inlet to any other appliance	12 inches (30 cm)	9 inches (23 cm)
K = Clearance to a mechanical air supply inlet	6 feet (1.83 m)	3 feet (91 cm) above if within 10 feet (3 m) horizontally
L = Clearance above paved sidewalk or paved driveway located on public property	7 feet (2.12 m)	See Footnote 5
M = Clearance under veranda, porch, deck or balcony	12 inches (30 cm) See Footnote 4	See Footnote 5

Footnotes

1 In accordance with the current CSA B419.1, Natural Gas and Propane Installation Code

2 In accordance with the current ANSI Z223.1 / NFPA 54, National Fuel Gas Code

3 A vent shall not terminate directly above a sidewalk or paved driveway that is located between two single family dwellings and serves both dwellings.

4 Permitted only if veranda, porch, deck or balcony is fully open on a minimum of two sides below the floor.

5 Clearance in accordance with local installation codes and the requirements of the gas supplier.

6 Dégagement conforme aux codes d'installation locaux et aux exigences du fournisseur de gaz.

Venting terminals shall not be recessed into a wall or siding.

GAS CONNECTION

The gas supply piping should have a separate gas shut-off valve and a 1/8" NPT plugged tapping upstream of the valve. The inlet regulator and main burner valve must be disconnected from the gas supply piping system during any pressure testing of that system at test pressures in excess of 1/2 psi (3.5kPa). The appliance must be isolated from the gas supply piping system by closing the main control valve during any pressure testing of the gas supply system at test pressures equal to or less than 1/2 psi (3.5kPa). After the gas supply has been connected, use a commercial gas leak detector or apply a soapy water solution to all the fittings to check for gas leaks. Never use a flame to test for leaks.

ROUTING OF GAS LINE

Correctly size and route the gas supply line from the supply regulator to the area where the appliance is to be installed as per requirements outlined in the latest edition of the National Fuel Gas Code, NFPA 54 (USA) or CAN/CSA-B1491(Canada).

Never use galvanized or plastic pipe, unless specified specifically for use with gas. Refer to the table below for proper sizing of the supply gas line. Gas lines must be routed, constructed and made of materials that are in strict accordance with local codes and regulations. A qualified individual such as a plumber or gas fitter should be hired to correctly size and route the gas supply line to the appliance.

Installing a gas supply line from the fuel supply to the appliance involves numerous considerations of materials, protection, sizing, locations, controls, pressure sediment, and other criteria. Sizing and/or installing of gas piping should only be performed by a qualified individual.

Schedule 40 Black Iron Pipe		
Inside Diameter (inches)		
Schedule 40 Pipe Length (feet)	Natural Gas	Propane Gas
0 - 10	1/2	3/8
10 - 40	1/2	1/2
40 - 100	1/2	1/2
100 - 150	3/4	1/2
150 - 200	3/4	1/2

Cold Climate Insulation

For cold climate installations, seal all cracks around your appliance with noncombustible material and wherever cold air could enter the room. It is especially important to insulate outside chase cavity between studs and under floor on which appliance rests, if floor is above ground level. Gas line holes and other openings should be caulked or stuffed with un-faced fiberglass insulation.

If the fireplace is being installed on a cement slab in cold climates, a sheet of plywood or other raised platform can be placed underneath to prevent conduction of cold transferring to the fireplace and into the room. It also helps to sheetrock inside surfaces and tape for maximum air tightness and caulk fire-stops.

Changes to chimney connection

The stove is supplied ready for a top outlet but can be changed to a rear outlet in the following manner:

Illustrations

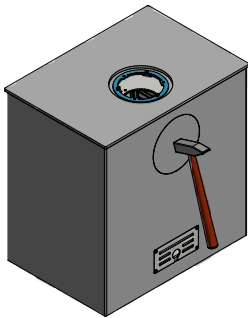

1. The knock-out blank at the rear of the stove can be knocked out using a hammer. This may require several blows. Be careful to only hit the blank.



2. Loosen the three screws on the outer flange on the top surface of the stove. And remove it.

3. Loosen the three screws on the inner flange on the bottom surface of the stove. And remove it.



4. Unscrew the outer cover plate at the rear of the stove and move it to the upper surface of the stove.

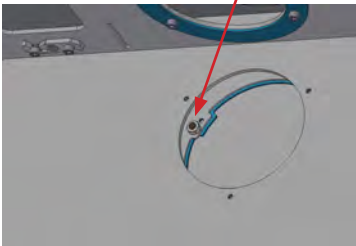

5. To open the door, a 10mm open-ended spanner is required to turn the two catches at the top and bottom of the door.



6. The secondary burners are removed by lifting them vertically up and out.



7. If the ceramic logs are fitted remove these.

8. Remove the Scamol fire bricks, (First remove the perforated plate)



9. The back plate can now be removed and the internal cover plate dismantled.



10. The internal cover plate is now fitted to the underside of the top plate as shown.



11 Fit the connecting pieces where the cover plates were and replace the back plate, logs and burners.



Conversion to bottled gas (LPG)

The stove is supplied configured for natural gas but can be converted to bottled gas (LPG). The conversion must only be carried out by an authorised gas engineer.

Conversion kit. Use article number 3713595. This set contains 4 new nozzles suitable for propane/LPG gas.

Also see press test under commissioning.



The nozzles for the secondary burners for LPG are marked "100"

The nozzles for the secondary burners for natural gas are marked "260"



The nozzle for the main burner for LPG is marked "80"

The nozzle for the main burner for natural gas is marked "120"



The nozzle for the pilot light for LPG is marked "27.1"

The nozzle for the pilot light for natural gas is marked "31.2"

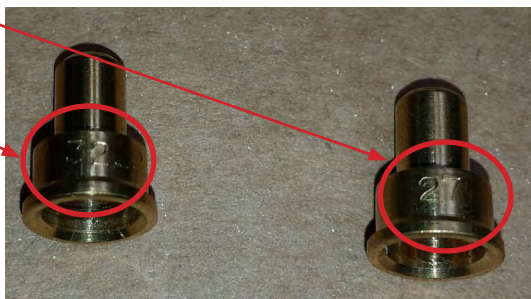

The gas unit needs to be dismantled to gain access to the nozzles. Do this in the following manner:

Lift the perforated plate up and out of the stove.



Loosen the four screws holding the gas unit in place.



Now the gas unit can be lifted out carefully by tilting and rotating the unit a little.



Once the gas unit has been dismantled, replace the four nozzles and adjust the three air intakes.

Replace the two nozzles for the secondary burners by loosening the coupling and carefully pulling the pipe out. Loosen the lock nut and then unscrew the nozzle. Fit the LPG nozzle and tighten the lock nut. Finally, re-tighten the coupling.



Remove the nozzle for the main burner by loosening the coupling and carefully pulling the pipe out and then unscrewing the nozzle. Fit the LPG nozzle and tighten the lock nut. Finally, re-tighten the coupling.

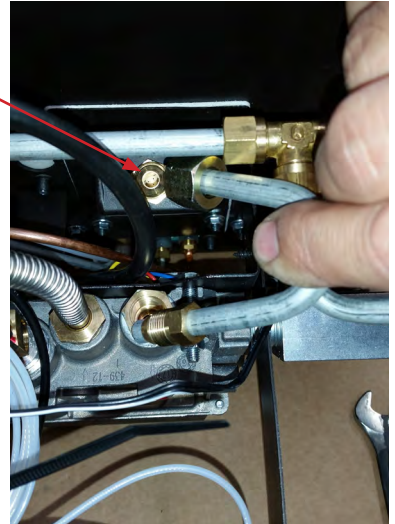

Replace the nozzle for the pilot light by loosening the coupling and carefully pulling the pipe out. Note. The small pilot light nozzle should now fall out and can be replaced with the LPG nozzle.



The air intake to the main burner is adjusted for LPG configuration by loosening the two nuts and pushing the plate all the way towards the burner. (The hole fully open)

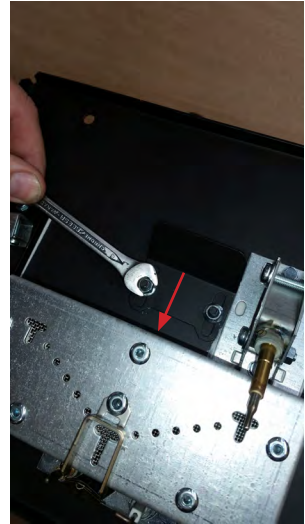

The two air intakes for the secondary burner are adjusted for LPG configuration by loosening the two screws and rotating the air intake by 90°. So that both holes in the vertical pipe are now open. (the small one at the rear and the large one at the front)

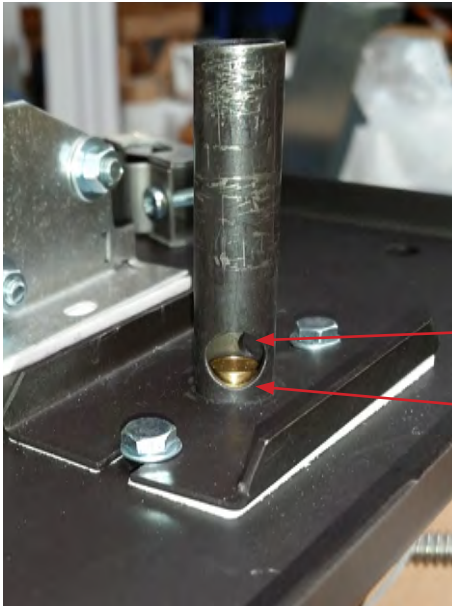
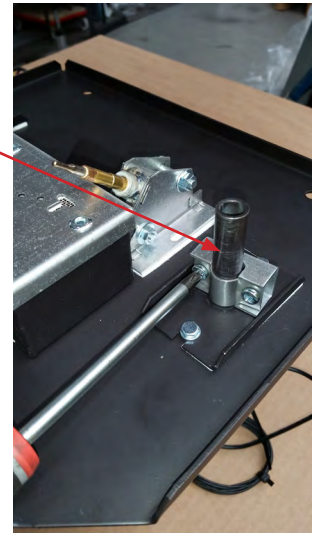

Small hole at the rear

Large hole at the front

The air intakes need to be reversed therefore when the stove is configured for LPG.

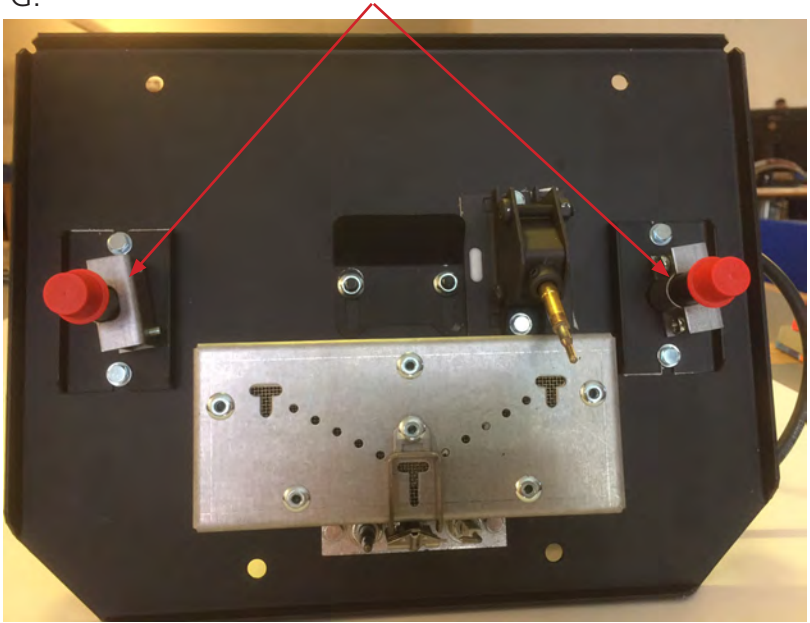

The gas unit is reassembled using the four screws. Replace the perforated plate and fully assemble the stove.
See Section: Assembly of secondary burners.

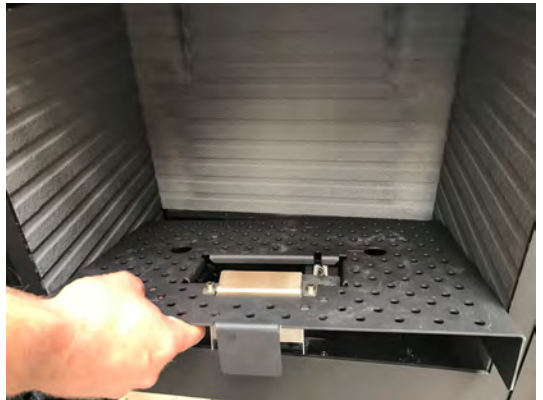

Fitting of Secondary burners

The burners are inserted above the pipes sticking through the perforated plate. Note that there is a right burner and a left one so it is important that they are positioned as shown, i.e., that the side with the extra holes faces out the way.



Front with holes



Rear without holes



Arrangement of "Embers" and "Logs"

When layers of embers and the ceramic logs are arranged in the combustion chamber, it is important that the pilot flame and its thermosensor are not covered over. And that no glowing material finds its way down under the pilot plate guard. The other thermosensor must also be kept free of the ceramic "Embers".

2nd thermosensor

Pilotflame

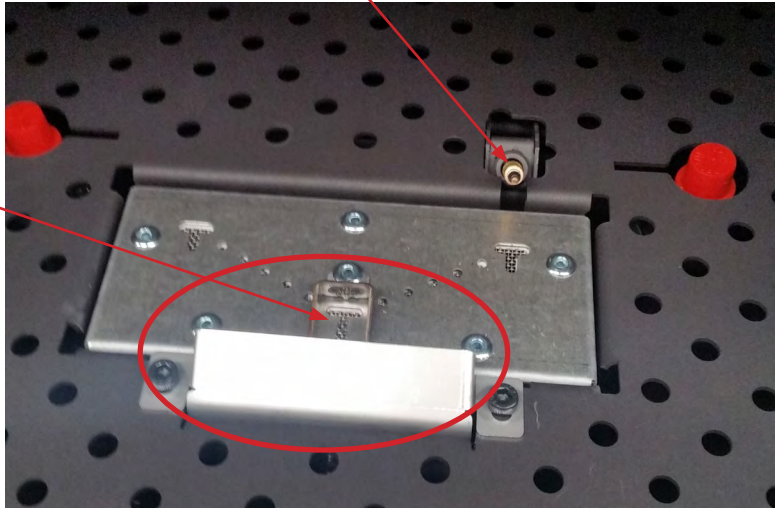

When commissioning or servicing the stove, it should be ensured that the cross-ignition from the pilot to the main burner works and that the secondary burners are easily ignited.

ceramic "Logs

Log 1



Log 2



Log 3



Log 4



Log A



Log 6



Log B



Log 5



Positioning of Logs and Embers



Spread the content of the bag of "Embers" as shown in the illustration.

Note: The pilot area must be kept clear of "Embers".

Position the 8 logs as shown.

Note, the two special logs marked A and B have a groove moulded on their undersides that fits on top of the two secondary burners.



Log 1

The glow wires are positioned between the "Embers" to emphasise the glow effect.



Log 2

Log 3



Log 4



Log 5



Log 6



Log A



Log B



Start-up

Insertion of Batteries.

The receiver on the stove and the remote control use batteries.

A set of batteries to be inserted prior to start-up is included. To access the battery box on the receiver, open the lid by rotating the two catches at the right-hand side by means of the 10mm open-ended spanner provided.

The receiver is located under the combustion chamber.

Push the battery cover on the receiver to the left to open it.

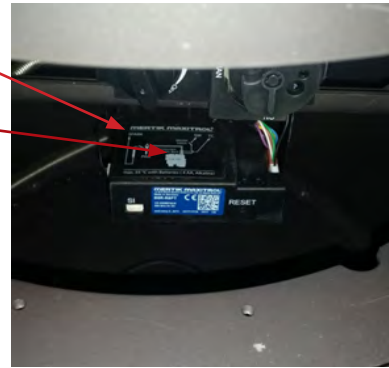

Use only good quality Alkaline batteries.

The batteries should be replaced at the start of a new heating season.

All batteries should be changed at the same time.

The batteries are removed from the receiver by pulling the red tab.

Never use sharp tools to tip the batteries out of the box.

The receiver uses 4 x AA 1.5 V batteries. Remember to replace the battery cover.



The batteries in the receiver must face the directions shown in the illustration.



The remote control uses 2 x AA 1.5 V batteries.



SETTING UP OF THE ELECTRONIC CODE

In order for the remote control to work, it must be synchronised with the stove's receiver. A code is selected automatically from 65,000 possible codes. The stove and remote control are synchronised in the following manner.

Press and hold down the "Reset" button until you hear a short beep followed by a long beep. Release the button.



Now you have 20 seconds to press the "Down Arrow" button on the remote control. Hold down the button until you hear two short beeps from the receiver. Now you can see the word "conn" on the remote control.

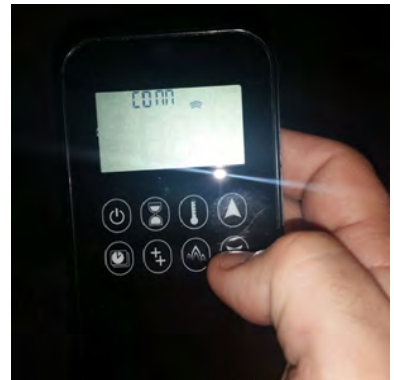

The receiver and remote control are now synchronised.

Commissioning

Check functioning of pilot light.

See User Instructions for use of remote control.

1. Start the pilot light.
2. Check that the pilot light remains ignited.
3. Turn off the pilot light.

Check the functioning of the main burner.

1. Turn on the pilot light
2. Turn on the main burner.
3. Check that the cross-ignition from the pilot light to the main burner occurs easily and that the main burner and pilot light remain ignited.
4. Check that the secondary burner's functions work.
5. Turn the stove off entirely.

Press Test

The stove is preset to provide the correct amount of heat (kW) as described under specifications. There is no need for further adjustment. "Inlet pressure" and "Burner pressure" must **ALWAYS** be measured.

1. Close the gas valve (Main Valve Knob)
2. Open the "Inlet pressure tap" on the gas valve and connect a manometer.
3. Check that the pressure measured concurs with the prescribed pressure from the gas supply company.
4. Carry out the test when the stove is at maximum heat output, including the secondary burners and when the stove only has the pilot light ignited.
5. If the pressure is low, check that the gas supply pipes are the correct size.
6. If the pressure is too high (more than 5 mbar over), the stove can still be installed but the gas supply company should be contacted.
7. The screw for the "Outlet pressure tap" on the gas valve is loosened and a manometer connected
8. Check that the pressure measured concurs with the pressure stated on the rating plate.
9. The value measured must be within $\pm 10\%$ of the stated pressure. If the pressure is not correct, it should be adjusted
10. Remove the plastic protection caps and adjust the pressure via the Pressure Regulator.

1 - 6 Inlet test

7 - 10 Outlet test

Note. After the pressure test and removal of the manometer, the screws in the "pressure tap" should be retightened. Check the system for gas leaks.

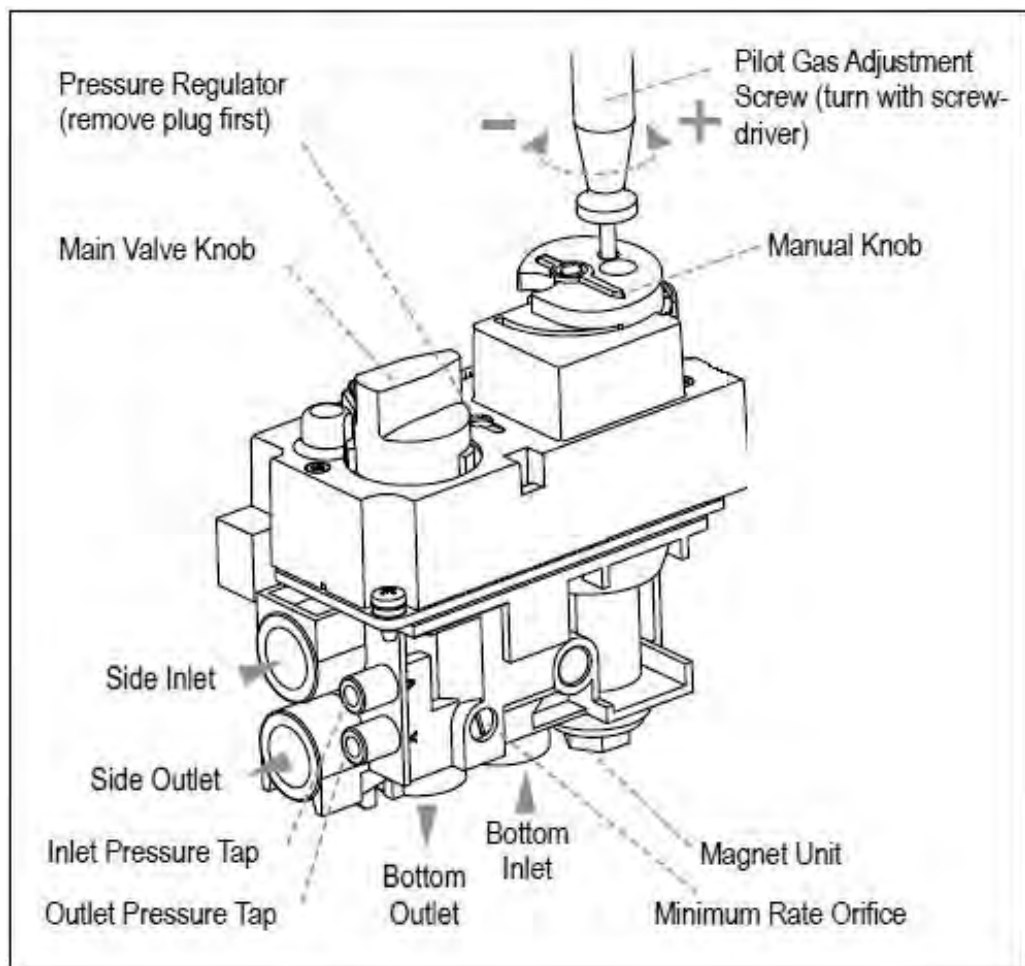

Initial ignition

For the initial ignition, ensure that all packaging, labels etc. have been removed from the stove and that the door glass has been cleaned.

Begin at low output, then the stove can be slowly turned up to a greater output. When the stove has been heated up, allow the stove to burn at high output for a couple of hours. This allows the best start and any damage is avoided.

Be aware that a strange smell and smoke from the stove's surface may occur during the initial ignition. This is because the paintwork and material need to harden but the smell will quickly disappear.

Ensure there is a lot of ventilation, preferably a draught. Children and pets should be kept at a safe distance from the stove during this process.

During this process, you should be careful not to touch the visible surfaces/glass (very hot!).

In addition, while heating up and cooling down, the stove may emit a so-called "clicking sound". This is due to the great differences in temperature the material is exposed to.

When the stove has been unused for a while, use the same approach as during the initial ignition.

User instructions

USER INSTRUCTIONS

GENERAL NOTES

NB!

The wiring for valves and receiver must be closed off before the ignition is put on. Failing to do so could damage the electronic system.

Batteries – Handset

- Low battery indicator on the handset.

Batteries – Receiver

- Low battery indicator: frequent beeping for 3 minutes when the motor is running.
- An AC adapter connected to a socket can be used instead of batteries.
- The module for controlling the ventilator speed and light/damper include a power point and batteries in the receiver for an automatic reserve power supply in the event of power failure.



⚠ WARNING

- If the mains adapter and battery are not used, it is recommended that they are replaced at the start of each heating season.
- Old or dead batteries must be quickly removed. If the batteries are left in the unit, they may overheat, leak and/or explode.
- Do NOT expose the batteries (even during storage) to direct sunlight, strong heat, fire, moisture or strong impacts. All these factors could contribute to the battery overheating, leaking and/or exploding.
- The batteries must be stored within the recommended temperature range. (Range of the battery's ambient temperature: 32-131 °F (0-55 °C)).
- New and old batteries should not be used at the same time. The same applies to batteries of different makes. If different batteries are used at the same time, this could contribute to the battery overheating, leaking and/or exploding.

Software version

Press on the  and  buttons at the same time. Now the software version is displayed.

Model number of the handset

Press on the  and  buttons at the same time. Now the model number of the handset is displayed.

Deactivation of functions

1. Install batteries All icons are displayed and flash.
2. While the icons are flashing, press on the relevant function button and hold down for 10 seconds.
3. The function icon remains flashing until deactivation is completed. Deactivation has been completed when the function icon and two horizontal lines are displayed.

NOTE: When you press on a deactivated button, nothing happens and two horizontal lines are displayed.

NOTE: Deactivation remains in effect after replacement of batteries.

Activation of functions

1. Install batteries All icons are displayed and flash.
2. A function is activated by pressing the relevant button and holding it down for 10 seconds.
3. The function icon continues to flash until activation is completed. Activation is completed when the function icon is displayed.

The following functions can be deactivated/activated

- CHILD PROOFING
- PROGRAM MODE
- THERMOSTATIC MODE (also deactivates PROGRAM MODE)
- ECO MODE
- LIGHT/DAMPER (OPERATION)
- ROOM VENTILATOR (OPERATION)
- HELP FUNCTION
- COUNTDOWN TIMER

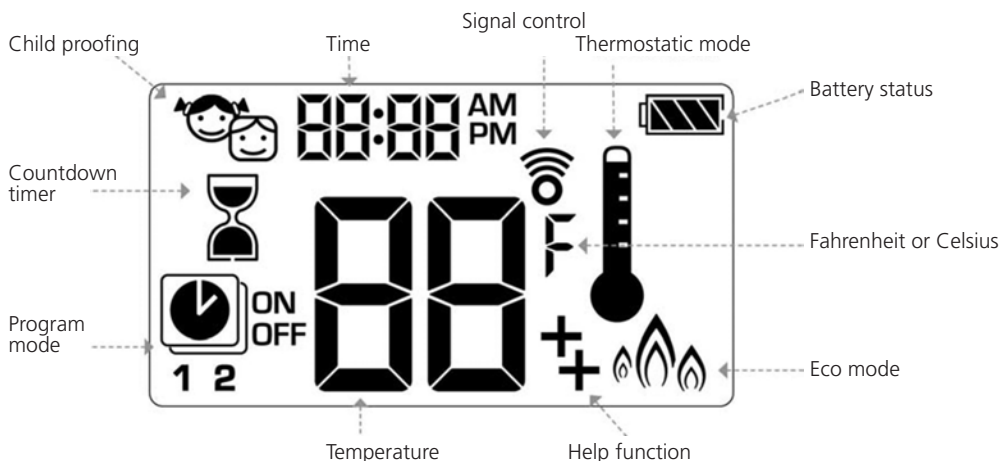

SETTING OF FAHRENHEIT or CELSIUS



Change between °C and °F by pressing and holding the and buttons at the same time.

NOTE: When °F is selected a twelve hour clock is displayed. When °C is selected a twenty-four hour clock is displayed.

CHILD PROOFING



ON: Activation takes place by pressing the and buttons at the same time. When is displayed, the handset cannot be used, apart from the OFF function.

OFF: De-activation takes place by pressing the and buttons at the same time. disappears.

SETTING THE TIME

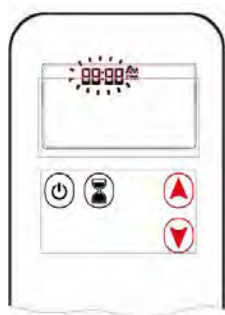

1. Press on the and buttons at the same time. **Day** flashes.
2. Press on the or button in order to select a number corresponding to day of the week (e.g., 1=Monday, 2=Tuesday, 3=Wednesday, 4=Thursday, 5=Friday, 6=Saturday 7=Sunday).
3. Press on the and buttons at the same time. **Hour** flashes.
4. Select hour by pressing on the or button.
5. Press on the and buttons at the same time. **Minutes** flashes.
6. Select minutes by pressing on the or button.
7. This is confirmed by pressing the and buttons at the same time or waiting.

HOW TO IGNITE

⚠ WARNING

When pilot ignition is confirmed, the motor automatically goes to maximum flame height.

One-button operation of handset

(Default setting)



- Press the button until you hear a short beep and a series of flashing lines confirm that the start sequence has commenced. Then release the button.
- The main gas supply starts as soon as pilot ignition is confirmed.
- The handset automatically goes into Manual mode after ignition of the main burner.

NB!

Move from one-button to two-button ignition by pressing and holding down the button for 10 seconds immediately after inserting the batteries. **ON** is displayed, and **1** flashes. When the change is made **1** changes to **2**.

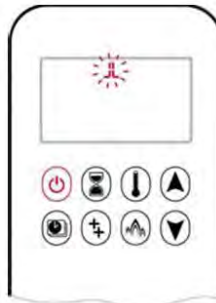

Two-button operation of handset

- Press the and buttons at the same time until you hear a short beep and a series of flashing lines confirm that the start sequence has commenced. Then release the buttons.
- The main gas supply starts as soon as pilot ignition is confirmed.
- The handset automatically goes into Manual mode after ignition of the main burner.

NB!

Move from two-button to one-button ignition by pressing and holding down the button for 10 seconds immediately after inserting the batteries. **ON** is displayed, and **2** flashes. When the change is made **2** changes to **1**.

⚠ WARNING

If the pilot light does not ignite after several attempts, turn the main valve button to **OFF**. Then follow the guidance for "SHUTTING OFF GAS TO APPLIANCE"

IN STANDBY MODE (PILOT LIGHT)

HANDSET

- Press and hold down the button to set the appliance to pilot light.

HOW TO EXTINGUISH THE FIRE

HANDSET

- Press the button to **EXTINGUISH**

NOTE: There will be a delay of 5 seconds before it is possible to re-ignite.

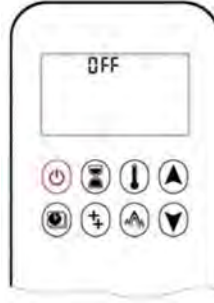

ADJUSTMENT OF FLAME HEIGHT

Handset

- The flame height is increased by pressing and holding down the button.
- To reduce the flame height or set the appliance to pilot flame, press and hold down the button.



SELECTING LOW FLAME and HIGH FLAME

NOTE: The background light must be on in order to obtain double-click operation with high and low flame.

- Low flame is activated by double-clicking on the button **LO** is displayed.

NOTE: The flame goes to high first before going to low flame.





• High flame is activated by double-clicking on the button **HI** is displayed.



Program mode
PROGRAMS 1 and 2 can both be programmed to start or stop at specific times at a set temperature.

⚠ WARNING

If the appliance does not work, follow the guidance "SHUTTING OFF GAS TO THE APPLIANCE"

COUNTDOWN TIMER



SETTING OPERATING TIME

1. Press and hold down the button until is displayed and **HOUR** flashes.
2. Select hour by pressing on the or button.
3. This is confirmed by pressing on the button. **Minutes** flashes.
4. Select minutes by pressing on the or button.
5. This is confirmed by pressing on the button.

OFF:

Press the button. Now and the countdown time disappear.

NB! Once the countdown has passed, the fire is extinguished. The countdown timer only works in Manual, Thermostatic and Eco modes. The maximum countdown time is 9 hours and 50 minutes.

OPERATING MODES

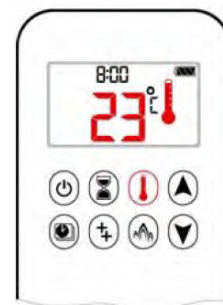

Thermostatic mode
The room temperature is measured and compared to the temperature set. The flame height is then adjusted automatically to reach the temperature set.



Eco mode
The flame height fluctuates between high and low. If the room temperature is lower than the temperature set, the flame height remains at high for a longer period of time. If the room temperature is higher than the temperature set, the flame height remains at low for a longer period of time. A cycle lasts 20 minutes.

THERMOSTATIC MODE



ON:

Press the button. is displayed, the pre-set is briefly displayed and then room temperature is displayed.

OFF:

1. Press the button.
2. Hold the or button down to enter Manual mode.
3. Press the button to enter Program mode.
4. Press the button to enter Eco mode.



SET-UP:

1. Press the button and hold it down until is displayed and the temperature flashes.
2. The set temperature is adjusted by pressing on the or button.
3. Confirm this by pressing the button or waiting.

PROGRAM MODE



ON:
Press the button 1 or 2, **ON** or **OFF** is displayed.



SETTING THE DAY:
5. **ALL** flashes. Press the or button to select from **ALL**, **SA:SU**, 1, 2, 3, 4, 5, 6, 7.
6. This is confirmed by pressing on the button.

ALL is selected.



OFF:
1. Press on the or or button to enter Manual mode.
2. Press on the button to enter Thermostatic mode.



SETTING OPERATING TIME (PROGRAM 1):

7. 1, **ON** is displayed, **ALL** is displayed briefly and **HOUR** flashes.
8. Select hour by pressing on the or button.
9. This is confirmed by pressing on the button.
 1, **ON** is displayed, **ALL** is displayed briefly and **Minutes** flashes.
10. Select minutes by pressing on the or button.
11. This is confirmed by pressing on the button.

SETTING TIME FOR TURNING OFF (PROGRAM 1):

12. 1, **OFF** is displayed, **ALL** is displayed briefly and **HOUR** flashes.
13. Select hour by pressing on the or button.
14. This is confirmed by pressing on the button.
 1, **OFF** is displayed, **ALL** is displayed briefly and **Minutes** flashes.
15. Select minutes by pressing on the or button.
16. This is confirmed by pressing on the button.

NB! The temperature set for Thermostatic mode is the temperature for the operating time in Program mode. If the time set for Thermostatic mode is changed, the temperature for the operating time in Program mode also changes.

Default setting:

OPERATING TIME (thermostatic mode) TEMPERATURE: 21 °C (70 °F)
TEMPERATURE FOR TURNING OFF "--" (only pilot light)



SETTING THE TEMPERATURE:

1. Press the button and hold it down until flashes. **ON** and the temperature set (setting in Thermostatic mode) are displayed.
2. Continue by pressing the button or waiting. **OFF** is displayed and temperature flashes.
3. Select temperature at which to shut down by pressing on the or button.
4. This is confirmed by pressing on the button.

NB! The temperature set (Thermostatic mode) and temperature for shutting down are the same for each day.



NB! Either continue to PROGRAM 2 and set operating time and time for shutting down or stop programming here. PROGRAM 2 remains deactivated.

NB! PROGRAMS 1 and 2 use the same operating temperature (Thermostatic mode) and temperature for shutting down for ALL, SA:SU and Daily Timer (1, 2, 3, 4, 5, 6, 7) When a new operating temperature (Thermostatic mode) and temperature for shutting down have been set, this temperature will become the new default setting.

NB! If ALL, SA:SU or Daily Timer are programmed for operating temperature and temperature for shutting down for PROGRAM 1 and PROGRAM 2, these will become the new default times. The batteries must be removed to clear temperatures, operating times and times for shutting down for PROGRAM 1 and PROGRAM 2.

SA:SU or Daily Timer (1, 2, 3, 4, 5, 6, 7) is selected.



- Set operating time and time for shut down by using the same approach as during "ALL selected" (above).
- SA:SU Set operating time and time for shut down for both Saturday and Sunday.
- Daily Timer: Unique operating times and times for shut down can be set for an individual weekday, for several week days or for all days of the week.
- Wait until set-up is complete.

HELP MODE



After ignition, burner 1 is ignited and burner 2 is in the last setting.



ON:

A burner is ignited by pressing the  button.  is displayed.

OFF:

A burner is turned off by pressing the  button.  disappears.

NB! The locking magnet valve cannot function manually. If the battery in the receiver runs out of power, it will remain in the last operating setting.

ECO MODE



ON:

Press the  button to enter Eco mode.  is displayed.

OFF:

Press the  button.  disappears.

WARNING**FIRE OR EXPLOSION HAZARD.**

Failure to follow safety warnings exactly could result in serious injury, death, or property damage.

Using stove without remote control.

Where the remote control cannot be used, it is possible to turn on the stove manually.

Always be very cautious if you chose to do this as the combustion chamber needs to be opened. The stove is ignited manually by opening the door so that there is access to the gas valve. This is located behind the door and under the combustion chamber.

Turn the gas valve clockwise to **OFF**.

Turn the button for manual control over to **man**.

Turn on the gas for the pilot flame by pressing and holding the Pilot gas valve down with a pointed object. Ignite the pilot flame with a match or similar item. The pilot gas valve must be held in for 20 seconds after the pilot flame has been ignited or until the pilot flame does not go out when the button is released.



Gas valve

Button for manual control

Pilot gas valve

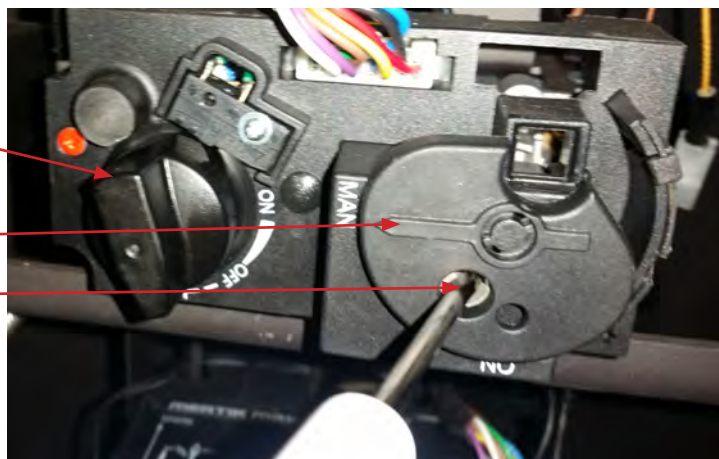

Turn on the pilot light



Once the pilot flame is ignited, turn the control button so that the arrow points down to (1) **ON**. Now the Main and secondary burners can be ignited and adjusted by turning the gas valve anticlockwise above to (2) **ON**. The gas valve should be fully open for a minimum of 30 seconds before the flames are turned down. When the correct setting is reached, the door can be closed. Turn off the stove again by opening the door and turning the gas valve back to (3) **OFF**
(As the pilot light will remain on, shut off the gas supply)



(1) ON

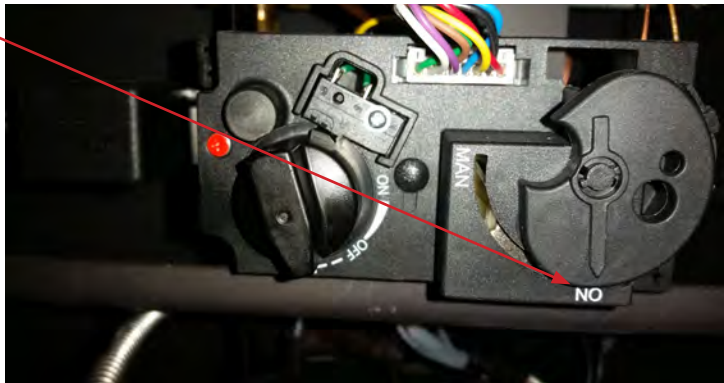

(2) Gas valve at ON

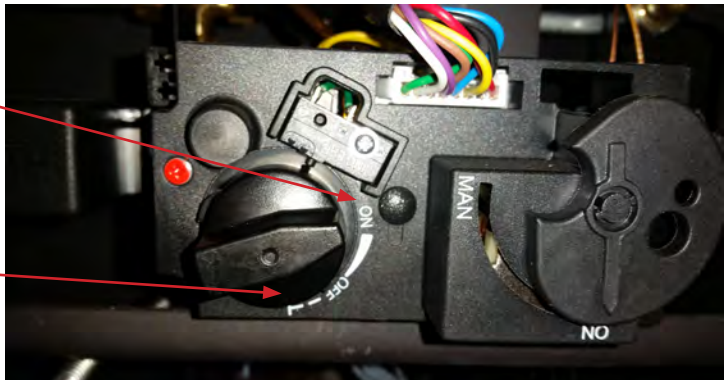

(3) Gas valve at OFF

Service.

The stove should be inspected by a gas engineer once a year. As a minimum, this inspection should ensure that the stove is working correctly and is safe to use.

Service.

Turn off the stove and shut off the gas supply. Ensure the stove is completely cold before starting. Rais cannot be held responsible for injuries arising from touching a hot stove.

Proposed service procedure.

1. Protect the floor by laying down a mat or other covering.
2. Open the door and carefully remove the ceramic logs including embers.
3. Use a vacuum cleaner to clean the burner and perforated sheet.
4. Lift and remove the secondary burners. Lift out the perforated sheet.
5. Vacuum the entire burner.
6. Clean the pilot burner joint with a soft brush and a vacuum cleaner. The thermosensors must not be bent or adjusted.
7. Put on the gas supply and check for leaks. Check that the burners and pilot unit are in good condition and work.
8. Replace the perforated plate
9. Replace embers and ceramic logs.
10. Check the flue gas system and chimney terminal and ensure it is not blocked.
11. Turn on the stove and check the set pressure.
12. Ensure the stove is safe to use.

MAINTENANCE INSTRUCTIONS

A qualified service agency should conduct an annual inspection and maintenance of your appliance including the overall installation and venting to keep it running safely. The following procedures should be performed only by a qualified service person. The gas supply should be turned off and the stove should be completely cool whenever a maintenance procedure is performed. All parts of the appliance that are removed for servicing must be replaced prior to operation.

WARNING:

Do not operate the appliance with the door open, cracked or broken glass. Replacement of the glass should be done by a qualified service person.

WARNING: Use only door assembly, P/N 12-0000-1001, 12-0000-1002, 12-0000-1003, 12-0000-1004 which includes the glass panel, frame and gasket. Do not use substitute materials. Do not strike or slam the glass front.

ONLY an authorized qualified installer may open the door/remove the glass. The end user must NOT open the door/remove the glass, as this may be unsafe and may result in voiding the manufacturer's warranty.

TURN OFF the gas before servicing the appliance. It is recommended that a qualified service technician perform an appliance check-up/service once a year.

Any safety screen or guard removed for servicing MUST BE REPLACED before operating this appliance.

DO NOT USE this appliance if any part has been under water. Immediately, call a qualified service technician to inspect the unit and to replace any part of the control system and any gas control that has been under water.

Any alteration to the product that causes soot or carbon to form and results in damage is not the responsibility of the manufacturer.

INSPECT the external vent cap on a regular basis to make sure that no debris, plants, trees, shrubs are interfering with the air flow.

CLEANING THE GLASS

WARNING: Never clean the glass while it is hot. Do not use abrasive cleaners or cleaners containing ammonia.

NOTE: A micro-fiber cleaning cloth and plain water is recommended by the glass manufacturer.

Burner Maintenance

The flames from the burner should be visually checked. The flame should be blue and yellow in color and candle-like in appearance.

Pilot Maintenance

The pilot flame must be visually checked. The pilot flame must always be present when the appliance is in operation.

The pilot burner has two distinct flames, one engulfing the thermocouple, the other reaches across to the main burner.

The area around the injector should be inspected and any lint or foreign material must be removed with a brush or vacuum.

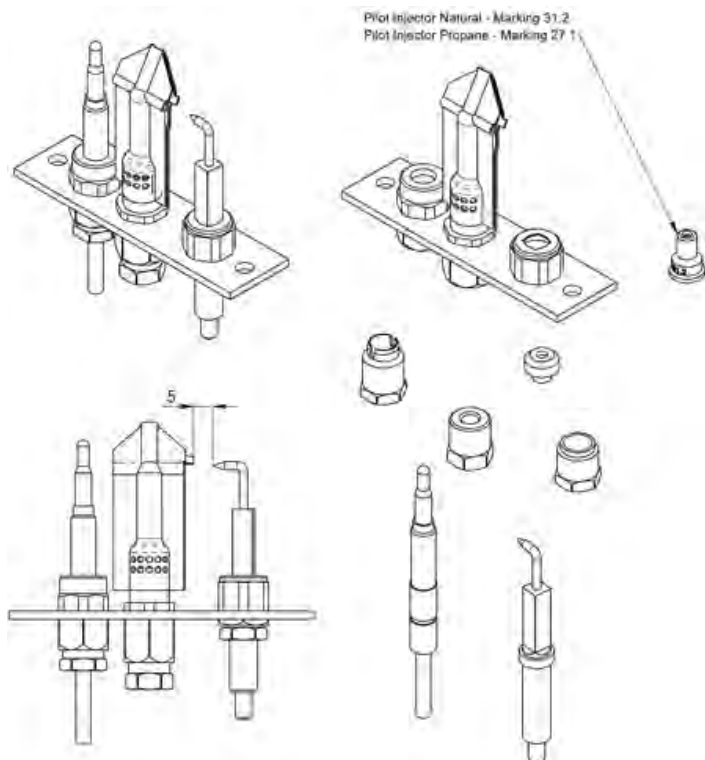

Thermocouple Maintenance

The thermocouple completeness and operation must be checked. The qualified engineer must confirm that the thermocouple is in place and not cracked or damaged.

INSPECTING THE VENTING

An inspection of both the inner and outer vent pipes and the vent terminal should be made as part of the annual service appointment. The venting must have no blockage and be in good repair. The vent manufacturer's instructions may provide specific details on vent inspection. Any vent sections that are disassembled must be reassembled and sealed as required.

This appliance should be inspected before use and at least annually by a qualified service person. It is imperative that control compartments and circulating air passageways of this appliance be kept clean.

CLEANING THE LOGS, BURNER AND FIREBOX

During the annual inspection and maintenance appointment, the service person should clean the logs, burner and firebox. An extra-soft brush should be used to gently clean the logs and burner. A vacuum cleaner may be used to clean the metal parts of the firebox. Replace the logs and embers after cleaning.

MAINTENANCE LOG

Date of Service _____
Serviced By _____
<u>Service Performed</u>
<input type="checkbox"/> Inspect Venting <input type="checkbox"/> Clean Burner, Logs & Firebox <input type="checkbox"/> Clean Control Area <input type="checkbox"/> Clean Convection Air System <input type="checkbox"/> Leak Test Gas Connections <input type="checkbox"/> Other _____

Date of Service _____
Serviced By _____
<u>Service Performed</u>
<input type="checkbox"/> Inspect Venting <input type="checkbox"/> Clean Burner, Logs & Firebox <input type="checkbox"/> Clean Control Area <input type="checkbox"/> Clean Convection Air System <input type="checkbox"/> Leak Test Gas Connections <input type="checkbox"/> Other _____

Date of Service _____
Serviced By _____
<u>Service Performed</u>
<input type="checkbox"/> Inspect Venting <input type="checkbox"/> Clean Burner, Logs & Firebox <input type="checkbox"/> Clean Control Area <input type="checkbox"/> Clean Convection Air System <input type="checkbox"/> Leak Test Gas Connections <input type="checkbox"/> Other _____

Date of Service _____
Serviced By _____
<u>Service Performed</u>
<input type="checkbox"/> Inspect Venting <input type="checkbox"/> Clean Burner, Logs & Firebox <input type="checkbox"/> Clean Control Area <input type="checkbox"/> Clean Convection Air System <input type="checkbox"/> Leak Test Gas Connections <input type="checkbox"/> Other _____

Date of Service _____
Serviced By _____
<u>Service Performed</u>
<input type="checkbox"/> Inspect Venting <input type="checkbox"/> Clean Burner, Logs & Firebox <input type="checkbox"/> Clean Control Area <input type="checkbox"/> Clean Convection Air System <input type="checkbox"/> Leak Test Gas Connections <input type="checkbox"/> Other _____

Date of Service _____
Serviced By _____
<u>Service Performed</u>
<input type="checkbox"/> Inspect Venting <input type="checkbox"/> Clean Burner, Logs & Firebox <input type="checkbox"/> Clean Control Area <input type="checkbox"/> Clean Convection Air System <input type="checkbox"/> Leak Test Gas Connections <input type="checkbox"/> Other _____

Cleaning

It is advisable to clean the stove of dust and foreign bodies each new heating season and especially if the stove has not been used for a long time. This can be done with a soft brush and a vacuum cleaner. Or with a damp cloth with a non-abrasive cleaning agent. Do not use corrosive or abrasive substances to clean this stove. The stove should be cold when cleaning and taking care of it.

If the glass is sooty:

- Only clean the glass when the stove is cold.
- Cleaning should be done with glass cleaner, which can be purchased from your RAIS dealer.

External cleaning is done using a soft cloth or brush.

Before each new heating season, the chimney and flue gas connection piece should always be checked for blockages. Check the stove externally and internally for damage. Check gaskets in particular. Only original spare parts may be used.

Cleaning of ceramic logs.

Remove the ceramic logs as described in points 1 - 4 under **Service**.

Clean the ceramic parts carefully with a soft brush and a vacuum cleaner.

Only replace damaged parts with original Rais specified parts.

Pack scrap ceramics in plastic bags and deliver to the correct waste locations.

It is recommended using a vacuum cleaner with a HEPA filter system.

Replace embers and close the door. Ensure the stove works correctly and is safe to use.

Servicing of the Burners.

(See section Conversion to bottled gas if necessary)

Remove the ceramic logs as described in points 1 - 4 under **Service**.

The pilot plate guard is removed by loosening the two M5 screws with a 4 mm hex key. By removing the two screws on the pilot unit with a 7 mm open-ended spanner, the pilot unit can be raised a little. Fittings on the underside of the pilot unit can be loosened by means of a 10 mm open-ended spanner. The thermosensor and pilot burner can be replaced.

To gain access to the nozzles on the main burner, the main burner unit must be removed from the stove. This is done by removing the 4 bolts holding the burner in place. Now the burner can be lifted out of the combustion chamber. Now there is free access to the nozzles.

When parts are replaced, only replace these with original Rais specified parts.

Accessories

3713506 - Mains Adapter
(Connecting the stove to a network)



3713507 - MyFire Wi-Fi Box incl. cable
(App-based control of the stove)



3713595 - Propane Gas LP Conversion kit



Installation of MyFire Wi-Fi Box

This appliance can be controlled remotely via an APP for your smart phone or tablet.

The MyFire Wi-Fi Box is connected to the Receiver, which is placed under the combustion chamber by opening the stove door and inserting the narrow plug on the Wi-Fi lead into the opening marked "SI".



The wide plug on the Wi-Fi lead is inserted into the Wi-Fi box.



When connecting the Wi-Fi box, use the mains adapter (connection to electricity mains) which is connected to the receiver.

The mains adapter is connected to the receiver on the stove. (batteries should be removed from the receiver to avoid leakage of batteries over time)

CONFIGURATION OF THE MYFIRE APP

NB!

When configuring the MyFire app you will need the SSID key and access code for the wireless network (Wi-Fi).

There are more detailed configuration and guidance instructions at www.myfireapp.com

START-UP CONFIGURATION

1. Download the MyFire app from the Apple App Store or Google Play Store.
2. Touch the screen to start configuration of the app.
3. Choose language, temperature (C° or F°) and time format (12 or 24 hours).

REGISTRATION

NOTE: You must register the appliance before you can log in. Registration is a one-off procedure.

1. Complete data and accept our Privacy Policy.
2. Touch "OK" in the pop-up message.
3. Press on the link to confirm verification of the e-mail address.
4. Now you will be shown a message that the MyFire app is registered.
5. Go back to the app.

LOGIN

1. Complete the access code for registration.
2. Accept "Terms and Conditions".
3. Press the "Login" button

CONNECT THE SMART UNIT TO THE NEW MYFIRE WI-FI BOX

1. Touch the icon ⊕
2. A message tells you that you need to enter the Wi-Fi settings for the SMART unit.
3. Touch `myfire_Wifi-Box_<number>`.
4. Enter the access code "MYFIREPLACE"

CONNECT THE MYFIRE WI-FI BOX TO THE WI-FI ROUTER

NOTE: The connection process can take between 1-10 minutes. Once the connection has been made, a pop-up message will tell you to enter the Wi-Fi settings for the SMART unit.

1. Select a name for your stove.
2. Write the name (SSID) on your Wi-Fi router.
3. Write the access code for your Wi-Fi router.
4. Press the "Connect" button.

NB!

In order to connect the MyFire Wi-Fi box to the Wi-Fi router (home network) you need to ensure:

- That a home network is available.
- That the name and access code of the home network are correct.
- That the Wi-Fi router's SSID key is not hidden.
- That the home network's signal is within range.
- That the Wi-Fi router supports the UDP protocol (User Datagram Protocol).

CONNECT SMART UNIT TO MYFIRE WI-FI BOX

NOTE: Once the connection has been made a pop-up message will tell you to enter the Wi-Fi settings for the SMART unit.

1. Touch the "OK" button if this is correct.

CONFIRM THE SETTINGS FOR THE FIREPLACE

1. After confirming the settings for fireplace, touch the "Finish" button.

A LIST OF CONNECTED MYFIRE WI-FI BOXES IS DISPLAYED

1. Touch the "Start App" button to finish the installation and configuration process.

The start screen is displayed and the MyFire app is ready to use.

NB!

Once the MyFire Wi-Fi box and MyFire app have been configured, the time should be configured in the settings in the MyFire app.

NB!

The active unit (Symax handset or SMART unit) is the last one used. The exception is however if the non-active unit is used to change the light, ventilator or AUX. The non-active unit makes the changes but the active unit remains unchanged if it is in Thermostatic, Program or Eco Mode. If a Profile contains a Thermostatic program or Eco setting, this will also contribute to the active unit remaining active.

NB!

If Thermostatic, Program or Eco mode are activated using the app, the corresponding icon and "APP" are displayed on the handset (see figure 25)



Figure 25: The app is connected (in Thermostatic mode)

NB!

When the motor is running, no information is exchanged between sender and receiver. Synchronisation takes place once the motor has stopped.

NB!

Room temperature data is transferred by the handset during synchronisation.

Spare parts list: Q-Tee II Gas

If spare parts other than those recommended by RAIS are used, the guarantee will be invalidated.

All replaceable parts can be purchased as spare parts from your RAIS dealer.

See spare part drawings (back of the manual).

xx: optional colour code

Pos.	Number	Article no.	Description
1	1	12-0000-1002xx	Glass door
2	1	12-0000-1001xx	Classic Glass door
3	1	8380401xx	Low socket
4	1	8380405xx	High socket
5	1	8380527xx	Low legs
6	1	8380529xx	High legs
7	1	12-0000-5502	Gasket set for Glass door
8	1	12-0000-5501	Gasket set for Glass door - Classic
9	1	12-0000-190101XX	Safety screen complete

Spare parts list: Q-Tee II C Gas

If spare parts other than those recommended by RAIS are used, the guarantee will be invalidated.

All replaceable parts can be purchased as spare parts from your RAIS dealer.

See spare part drawings (back of the manual).

xx: optional colour code

Pos.	Number	Article no.	Description
1	1	12-0000-1004xx	Glass door
2	1	12-0000-1003xx	Classic Glass door
3	1	8340401xx	Low socket
4	1	8340405xx	High socket
5	1	8340528xx	Low legs
6	1	8340534xx	High legs
7	1	12-0000-5504	Gasket set for Glass door
8	1	12-0000-5503	Gasket set for Glass door - Classic
9	1	12-0000-1902XX	Safety screen complete

Spare parts list:

Gas unit

If spare parts other than those recommended by RAIS are used, the guarantee will be invalidated.

All replaceable parts can be purchased as spare parts from your RAIS dealer.

Pos.	Number	Article no.	Description
1		3713504	Ceramic Log + Ember set
2		G30-ZP2-312	Pilot Assembly Natural
3		G30-ZP2-271	Pilot Assembly LPG
4		G30-SPK1	Electrode
5		G60-ZKIS1/1500	Electrode Lead
6		CG30182	Thermocouple
7		YG46177	Injector Natural Front
8		NG05077	Injector Natural Left & Right
9		RG10077	Injector LPGFront
10		WG04077	Injector LPG Left & Right
11		RA10092	Burner Top Assembly Front
12		RA10L76	Burner Raised Assembly Left
13		RA10R76	Burner Raised Assembly Right
14		RK10P07	Complete Burner Assembly Natural RK10N07 Complete Burner Assembly LPG
15		RK10-SEAL-05	Burner Seal Set
16		12-0000-040101	Grate Assembly
17		RK10_N1_GV60	Gas Valve Assembly Natural
18		RK10_P1_GV60	Gas Valve Assembly LPG
19		GV-S60C/12	Latching Solenoid
20		G6R-R4AS	Receiver unit
21		G6R-H4D	Handset

Q-Tee II Gas

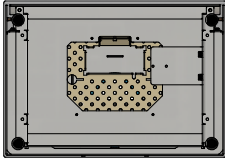

A-A

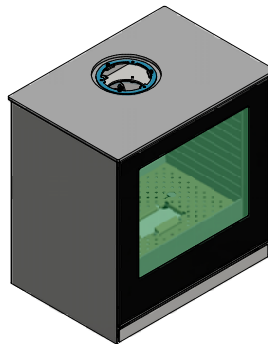
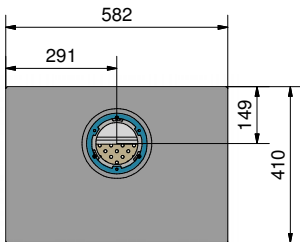
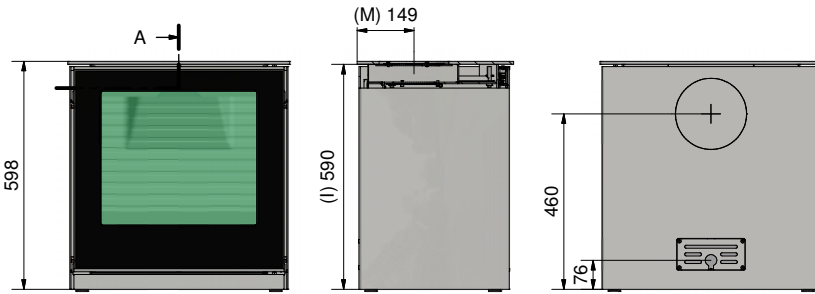

Q-Tee II Gas - Low Socket

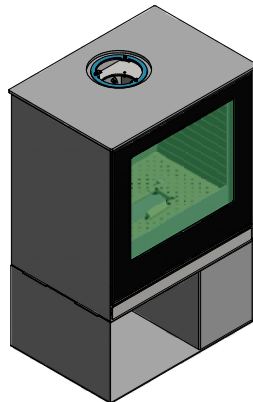
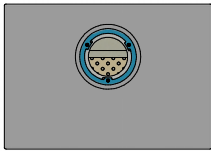
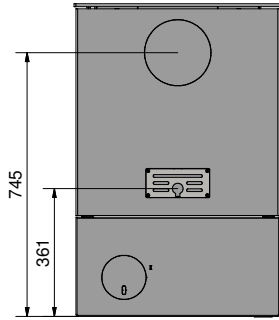
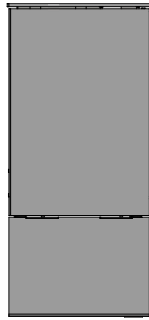
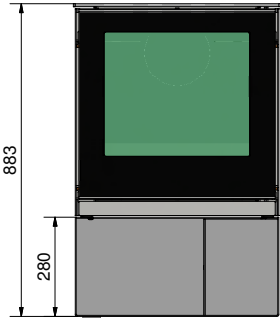
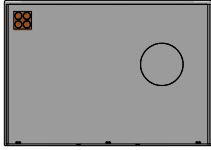

Q-Tee II Gas - High Socket

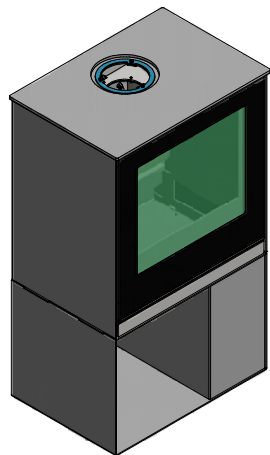
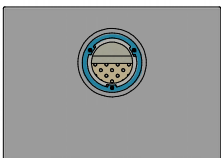
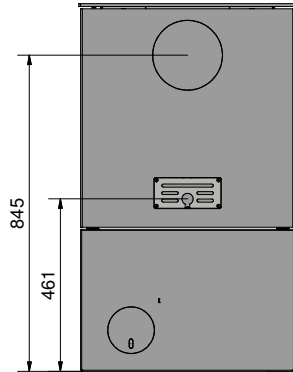
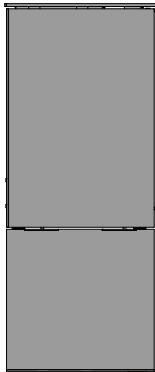
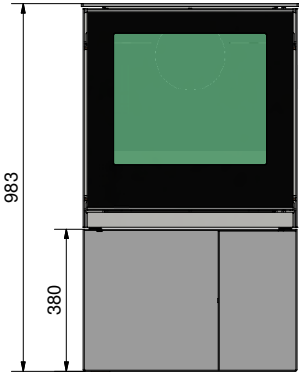
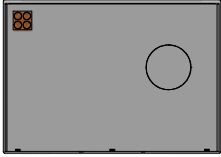

Q-Tee II Gas - Low Legs

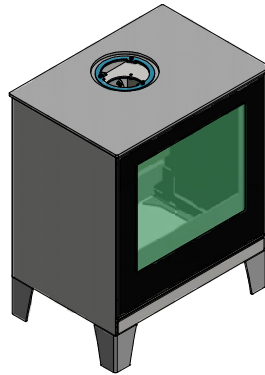
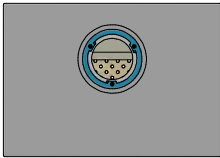
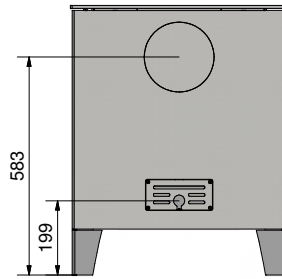
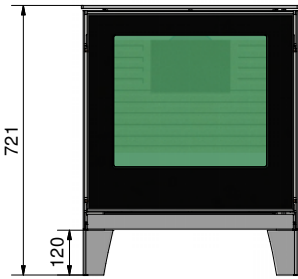
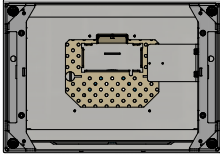

Q-Tee II Gas - High Legs

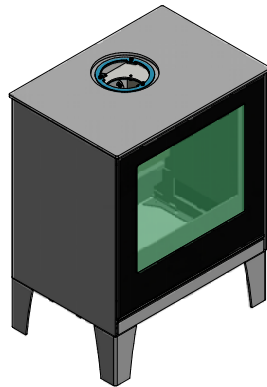
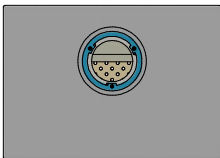
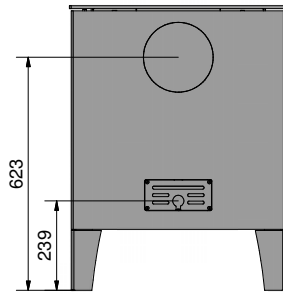
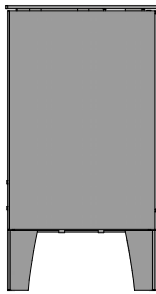
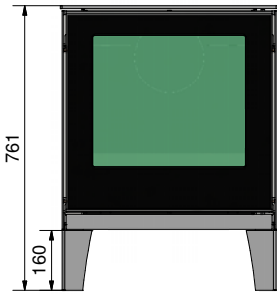
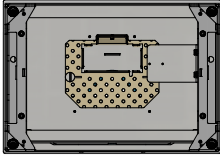

Q-Tee II C Gas

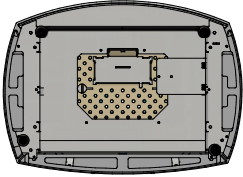

A-A

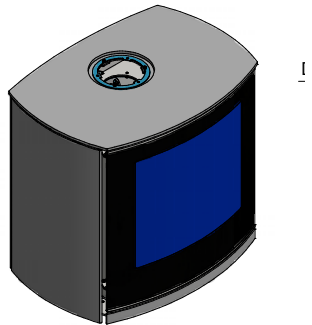
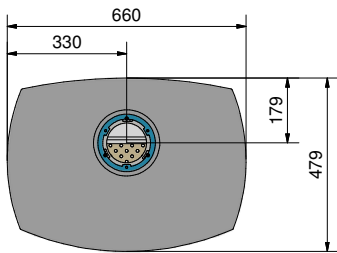
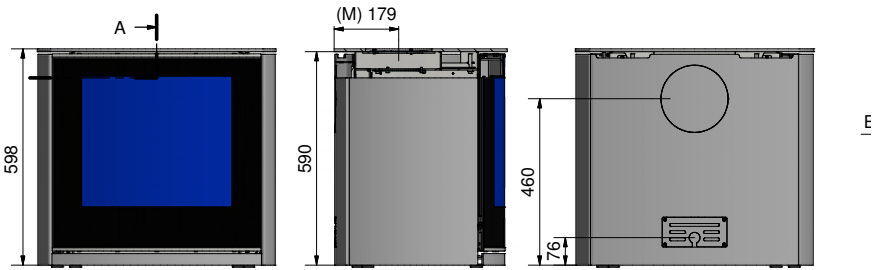

Q-Tee II C Gas - Low Socket

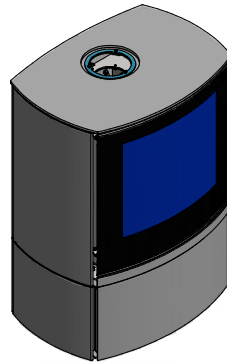
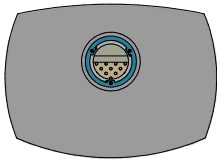
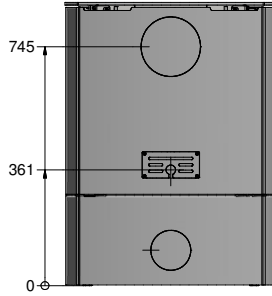
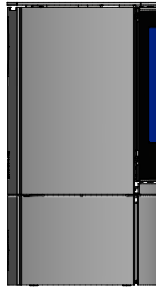
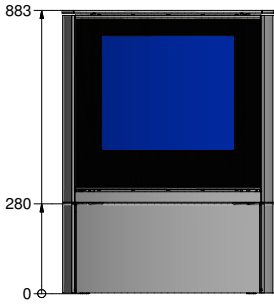
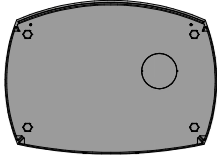

Q-Tee II C Gas - High Socket

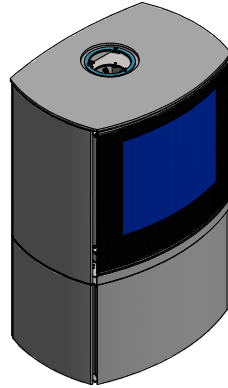
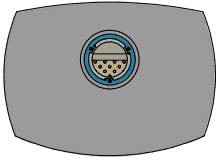
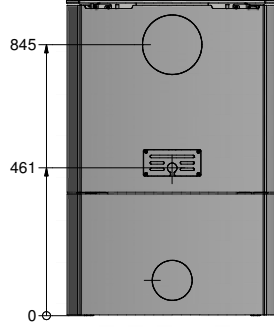
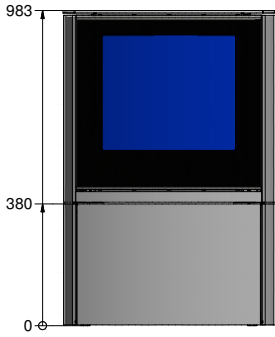
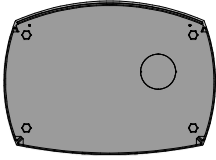

Q-Tee II C Gas - Low Legs

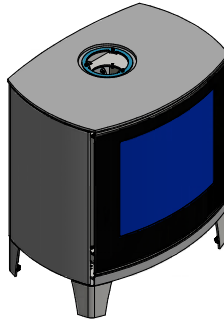
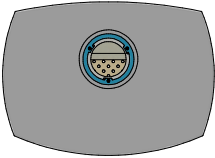
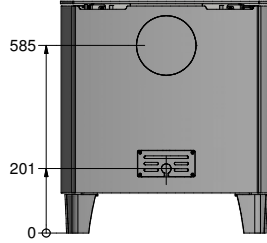
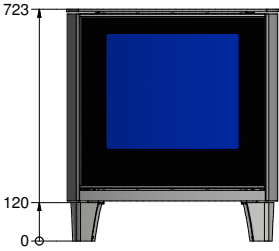
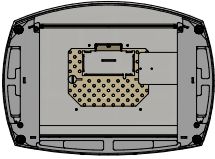

Q-Tee II C Gas - High Legs

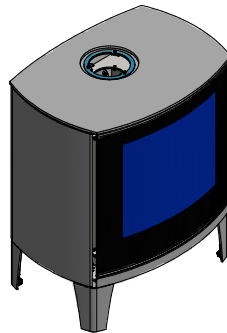
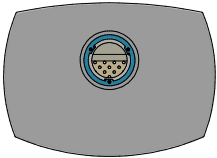
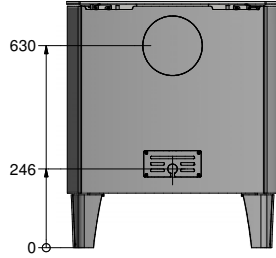
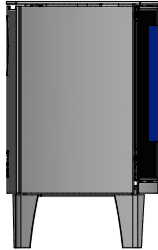
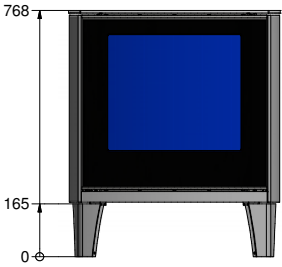
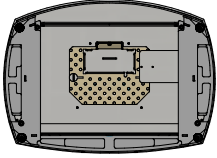

Q-Tee II Gas - Spareparts

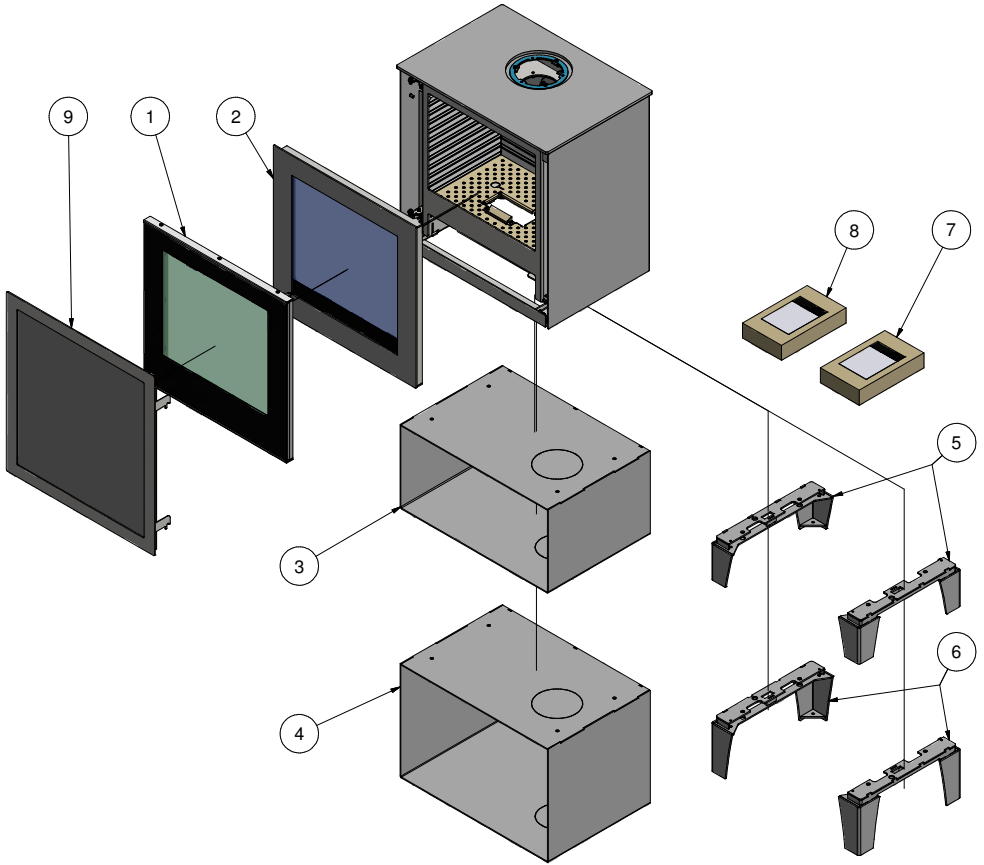

Q-Tee II C Gas - Spareparts

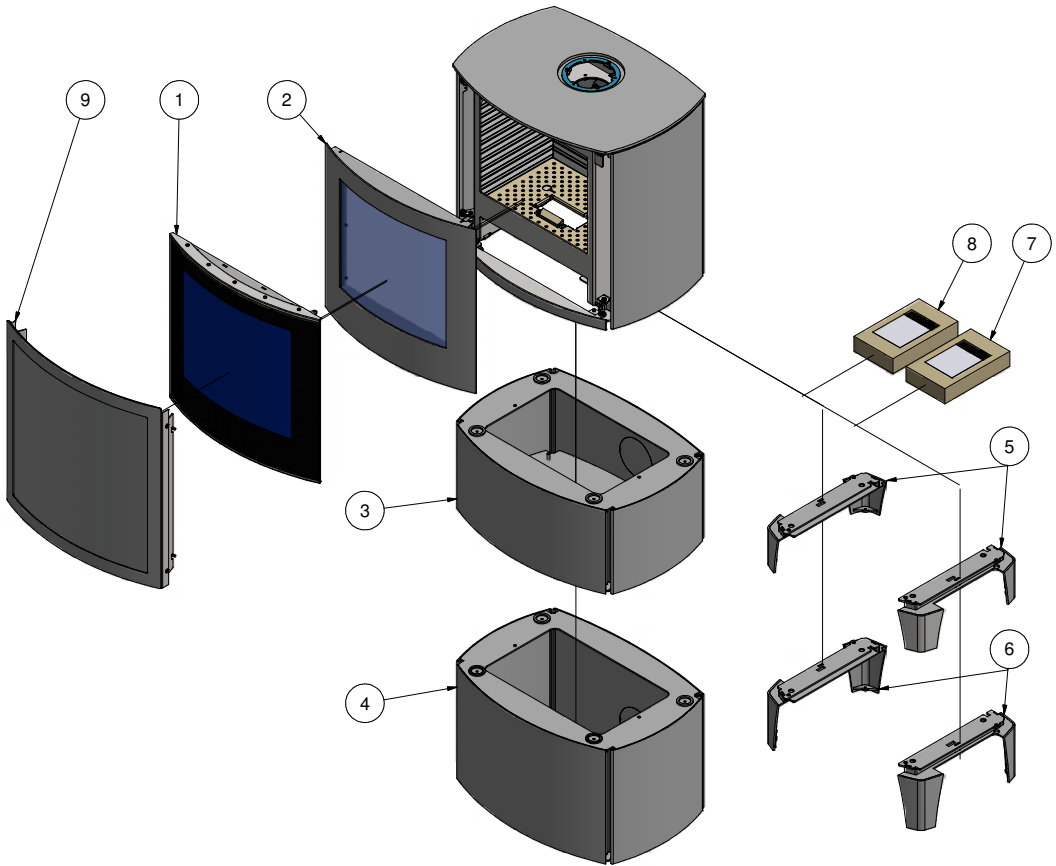

INSTALLATION RECORD

The installer should complete the form below that describes the details of the installation. Having this written record of installation information available will greatly expedite trouble-shooting should any problem arise with your stove. The installer should keep a duplicate of this form for their records.

DATE PURCHASED:

--

DEALER:

--

INSTALLER:

--

STOVE SERIAL NUMBER:

--

DATE INSTALLED:

--

FUEL:

<input checked="" type="checkbox"/> NAT.GAS	<input type="checkbox"/>
---	--------------------------

<input type="checkbox"/> LP GAS	<input type="checkbox"/>
---------------------------------	--------------------------

INLET PRESSURE MEASURED AFTER INSTALLATION:

--

 IN. WC

MANIFOLD PRESSURE MEASURED AFTER INSTALLATION:

HIGH FIRE:

--

 IN.WC

LOW FIRE:

--

 IN.WC

VENTING BRAND:

--

VENT CONFIGURATION:

VERTICAL RISE

--

 FT

HORIZONTAL RUN

--

 FT

NUMBER OF ELBOWS

0	1	2	3
---	---	---	---

TERMINATION TYPE:

<input type="checkbox"/> VERTICAL	<input type="checkbox"/> HORIZONTAL	<input type="checkbox"/> SNORKEL
-----------------------------------	-------------------------------------	----------------------------------

OTHER INSTALLATION NOTES.

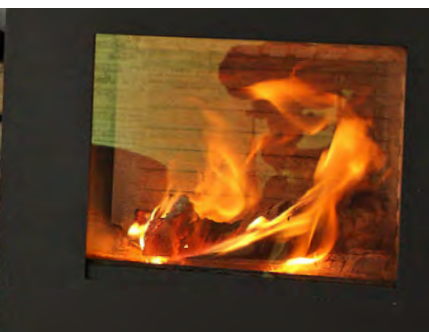

RAIS[®]
ART OF  FIRE

RAIS A/S
Industrivej 20
DK-9900 Frederikshavn
Denmark
www.rais.dk